



MAKO[®]
MODEL 2000
CASH DISPENSER

OPERATION MANUAL

Version 4.1

TDN 07102-00010 09/00

CORPORATE HEADQUARTERS:

522 E. Railroad Street
Long Beach, MS 39560
PHONE: (228) 868-1317
FAX: (228) 868-0437

**RMA (RETURN MATERIAL AUTHORIZATION)
RETURN ADDRESS:**

21405 B Street
Long Beach, MS 39560

COPYRIGHT NOTICE

Copyright © 2000 Triton Systems, Inc. All rights reserved. No part of this publication may be reproduced, transmitted, transcribed, stored in a retrieval system, or translated into any human or computer language, in any form, by any means whatsoever, without the express written permission of Triton Systems, Inc.

MAKO is a registered trademark of Triton Systems, Inc.

FCC COMPLIANCE

Warning:

Changes or modifications to this unit not expressly approved by the party responsible for compliance could void the user's authority to operate the equipment.

Note 1:

This equipment has been tested and found to comply with the limits for a Class A digital device, pursuant to Part 15 of FCC Rules. These limits are designed to provide reasonable protection against harmful interference when the equipment is operated in a commercial environment. This equipment generates, uses, and can radiate radio frequency energy and, if not installed and used in accordance with the instruction manual, may cause harmful interference to radio communications. Operation of this equipment in a residential area is likely to cause harmful interference in which case the user will be required to correct the interference at his own expense.

Note 2:

The Terminal complies with Part 68 of the FCC Rules. The label affixed to this equipment contains, among other information, the FCC Registration Number and Ringer Equivalence Number (REN) for this equipment. You must, upon request, provide this information to your telephone company.

The REN is useful to determine the quantity of devices you may connect to your telephone line and still have all of those devices ring when your telephone number is called. In most, but not all areas, the sum of the REN's of all devices connected to one line should not exceed five (5.0). To be certain of the number of devices you may connect to your line, as determined by the REN, you should contact your local telephone company to determine the maximum REN for your calling area.

The following jacks must be ordered from the telephone company in order to interconnect this equipment with the public communication network: RJ-11.

An FCC compliant telephone cord and modular plug is provided with this equipment. This equipment is designed to be connected to the telephone network or premises wiring using a compatible modular jack which is Part 68 compliant. See Installation instructions for details.

If your Terminal causes harm to the telephone network, the Telephone Company may discontinue your service temporarily. If possible, they will notify you in advance. But if advance notice is not practical you will be notified as soon as possible. You will be informed of your right to file a complaint with the FCC.

Your telephone company may make changes in its facilities, equipment, operations or procedures that could affect the proper functioning of your equipment. If they do, you will be notified in advance to give you an opportunity to maintain uninterrupted telephone service.

Connections to party lines are subject to state tariffs. Contact your local telephone company if you plan to use this equipment on party lines.

This equipment cannot be used on public coin service lines provided by the telephone company.

The Terminal is hearing-aid compatible (HAC) per Section 68.316, FCC Rules and Regulations.

If you have trouble with the Terminal, please contact us at the address above for information on obtaining service or repairs. The telephone company may ask that you disconnect this equipment from the network until the problem has been corrected or until you are sure that the equipment is not malfunctioning.

The maintenance section of this manual describes troubleshooting steps which one can take in the event of equipment problems.

CANADIAN EMISSION REQUIREMENTS

This digital apparatus does not exceed the Class A limits for radio noise emissions from digital apparatus set in the Radio Interference Regulations of the Canadian Department of Communications.

Le présent appareil numérique n'émet pas de bruits radioélectriques dépassant les limites applicables aux appareils numériques de la Class A prescrites dans le Règlement sur le brouillage radioélectrique édicté par le ministère des Communications du Canada.

NOTICE:

The Industry Canada label identifies certified equipment. This certification means that the equipment meets telecommunications network protective, operational and safety requirements as prescribed in the appropriate Terminal Equipment Technical Requirements document(s). The Department does not guarantee the equipment will operate to the user's satisfaction.

Before installing this equipment, users should ensure that it is permissible to be connected to the facilities of the local telecommunications company. The equipment must also be installed using an acceptable method of connection. The customer should be aware that compliance with the above conditions may not prevent degradation of service in some situations.

Repairs to certified equipment should be coordinated by a representative designated by the supplier. Any repairs or alterations made by the user to this equipment, or equipment malfunctions, may give the telecommunications company cause to request the user to disconnect the equipment.

Users should ensure for their own protection that the electrical ground connections of the power utility, telephone lines and internal metallic water pipe system, if present, are connected together. This precaution may be particularly important in rural areas. Caution: Users should not attempt to make such connections themselves, but should contact the appropriate electric inspection authority, or electrician, as appropriate.

NOTICE:

The Ringer Equivalence Number (REN) assigned to each terminal device provides an indication of the maximum number of terminals allowed to be connected to a telephone interface. The termination on an interface may consist of any combination of devices subject only to the requirement that the sum of the Ringer Equivalence Numbers of all the devices does not exceed 5.

AVIS:

L'étiquette d'Industrie Canada identifie le matériel homologué. Cette étiquette certifie que le matériel est conforme aux normes de protection, d'exploitation et de sécurité des réseaux de télécommunications, comme le prescrivent les documents concernant les exigences techniques relatives au matériel terminal. Le Ministère n'assure toutefois pas que le matériel fonctionnera à la satisfaction de l'utilisateur.

Avant d'installer ce matériel, l'utilisateur doit s'assurer qu'il est permis de le raccorder aux installations de l'entreprise locale de télécommunication. Le matériel doit également être installé en suivant une méthode acceptée de raccordement. L'abonné ne doit pas oublier qu'il est possible que la conformité aux conditions énoncées ci-dessus n'empêche pas la dégradation du service dans certaines situations.

Les réparations de matériel homologué doivent être coordonnées par un représentant désigné par le fournisseur. L'entreprise de télécommunications peut demander à l'utilisateur de débrancher un appareil à la suite de réparations ou de modifications effectuées par l'utilisateur ou à cause de mauvais fonctionnement.

Pour sa propre protection, l'utilisateur doit s'assurer que tous les fils de mise à la terre de la source d'énergie électrique, des lignes téléphoniques et des canalisations d'eau métalliques, s'ils y en a, sont raccordés ensemble. Cette précaution est particulièrement importante dans les régions rurales. Avertissement: L'utilisateur ne doit pas tenter de faire ces raccordements lui-même; il doit avoir recours au service d'inspection des installations électriques, ou à un électricien, selon le cas.

AVIS:

L'indice d'équivalence de la sonnerie (IES) assigné à chaque dispositif terminal indique le nombre maximal de terminaux qui peuvent être raccordés à une interface. La terminaison d'une interface téléphonique peut consister en une combinaison de quelques dispositifs, à la seule condition que la somme d'indices d'équivalence de la sonnerie de tous les dispositifs n'exède pas 5.

CONTENTS

SECTION 1 - INTRODUCTION	1-1
WHAT'S IN THIS MANUAL	1-2
WHAT IS MAKO?	1-3
BALANCING DAILY TRANSACTIONS	1-4
SECTION 2 - FEATURES	2-1
MAKO CASH DISPENSER	2-2
NEW FEATURES	2-2
STANDARD FEATURES	2-3
SECTION 3 - OPERATION AND SETUP	3-1
BASIC OPERATION	3-2
MENU-BASED OPERATION	3-2
KEYPAD OPERATION	3-3
CHANGING TO MANAGEMENT FUNCTIONS	3-5
INITIAL DISPENSER CONFIGURATION	3-6
ADDITIONAL PARAMETERS	3-8
SETUP PARAMETERS	3-9
SECTION 4 - HANDLING CASSETTES	4-1
CASH CONDITION	4-2
USED CURRENCY	4-2
NEW OR UNCIRCULATED CURRENCY	4-2
REPLENISHING CASSETTES	4-2
SECTION 5 - MANAGEMENT FUNCTIONS	5-1
INTRODUCTION	5-2
ACCESSING THE MANAGEMENT FUNCTIONS MENU	5-2
FUNCTION AVAILABILITY	5-3
MANAGEMENT FUNCTIONS CHART	5-4
FUNCTION: MANAGEMENT FUNCTIONS	5-5
FUNCTION: CLOSE	5-6
FUNCTION: SCHEDULE CLOSE	5-7
FUNCTION: CHANGE SCHEDULE	5-8
FUNCTION: TRIAL CASSETTE BALANCE	5-9
FUNCTION: TRIAL CLOSE	5-10
FUNCTION: DAY CLOSE	5-11
FUNCTION: SEND TERMINAL TOTALS	5-12
FUNCTION: ENTER QTY. IN CASSETTE	5-13
FUNCTION: CASSETTE CLOSE	5-14
FUNCTION: DIAGNOSTICS	5-15
FUNCTION: STATUS	5-16
FUNCTION: CLEAR DISPENSE ERROR	5-17
FUNCTION: TEST DISPENSE	5-18
FUNCTION: FORMAT MEMORY EXPANSION CARD	5-19
FUNCTION: TEST RECEIPT PRINTER	5-20
FUNCTION: VERSION #'S	5-21
FUNCTION: MORE DIAGNOSTICS	5-22

CONTENTS

FUNCTION: RESET/TEST MODEM.....	5-23
FUNCTION: MODEM SPEAKER ON/OFF	5-24
FUNCTION: SCAN CARD	5-25
FUNCTION: LANGUAGE/IDIOMA	5-26
FUNCTION: ENGLISH/INGLES	5-27
FUNCTION: SPANISH/ESPAÑOL	5-28
FUNCTION: ENABLE/DISABLE CUST. OPTION	5-29
FUNCTION: JOURNAL	5-30
FUNCTION: PRINT JOURNAL	5-31
FUNCTION: CLEAR JOURNAL	5-32
FUNCTION: PRINT LAST X ENTRIES	5-33
FUNCTION: PASSWORD MAINTENANCE	5-34
FUNCTION: MASTER PASSWORD	5-35
FUNCTION: ADMINISTRATION PASSWORD	5-36
FUNCTION: TERMINAL CONFIGURATION	5-37
FUNCTION: PRINTER SETTINGS	5-38
FUNCTION: SET PRINT LENGTH	5-39
FUNCTION: LOW RECEIPT PAPER	5-40
FUNCTION: PRINTER GRAPHICS	5-41
FUNCTION: RANDOM/LEVEL PRIZE COUPONS	5-42
FUNCTION: ENTER PRIZE LEVEL MSG.	5-43
FUNCTION: ENTER RANDOM PRIZE MSG.	5-44
FUNCTION: ENABLE/DISABLE COUPON AWARDS	5-45
FUNCTION: SET LEVEL PRIZE AMOUNT	5-46
FUNCTION: SET RANDOM WINNING %	5-47
FUNCTION: CHANGE MESSAGES	5-48
FUNCTION: MARKETING MESSAGE	5-49
FUNCTION: SURCHARGE MESSAGES	5-50
FUNCTION: WELCOME MESSAGE	5-52
FUNCTION: SURCHARGE OWNER	5-53
FUNCTION: CHANGE EXIT MESSAGE	5-54
FUNCTION: STORE MESSAGE	5-55
FUNCTION: TERMINAL OWNER	5-56
FUNCTION: TERMINAL PARAMETERS	5-57
FUNCTION: SET TERMINAL #	5-58
FUNCTION: RESET SEQ #	5-59
FUNCTION: SURCHARGE MODE	5-60
FUNCTION: SURCHARGE PERCENT	5-61
FUNCTION: ENABLE/DISABLE SURCHARGE MODE	5-62
FUNCTION: SURCHARGE LOCATION	5-63
FUNCTION: BLOCK ISO'S	5-64
FUNCTION: SURCHARGE AMOUNT	5-66
FUNCTION: CASSETTE SETUP	5-67
FUNCTION: INTERNATIONAL CURRENCY	5-68
FUNCTION: MAXIMUM AMOUNT	5-69
FUNCTION: MULTIPLE AMOUNT	5-70
FUNCTION: EXTENDED AMOUNTS	5-71
FUNCTION: FAST CASH AMOUNT	5-72

CONTENTS

FUNCTION: KEY MANAGEMENT	5-73
FUNCTION: ENTER MAC MASTER KEY	5-74
FUNCTION: ENTER PIN MASTER KEY	5-76
FUNCTION: INJECT MASTER KEY	5-78
FUNCTION: ENTER MAC WORKING KEY	5-79
FUNCTION: ENTER PIN WORKING KEY	5-81
FUNCTION: DOWNLOAD WORKING KEYS	5-83
FUNCTION: TELEPHONE	5-84
FUNCTION: PRIMARY NUMBER	5-85
FUNCTION: BACKUP NUMBER	5-86
FUNCTION: DATAPAK ACCESS CODE	5-87
FUNCTION: PREDIAL ON/OFF	5-88
FUNCTION: COMPUSERVE ID	5-89
FUNCTION: MODEM SETUP	5-90
FUNCTION: DIAL MODE	5-91
FUNCTION: DIAL RATE	5-92
FUNCTION: BAUD RATE	5-93
FUNCTION: MODEM SETUP STRING	5-94
FUNCTION: RESET/TEST MODEM	5-95
FUNCTION: MORE	5-96
FUNCTION: ADJUSTCONTRAST	5-97
FUNCTION: RECEIPT OPTION	5-98
FUNCTION: TRITON CONNECT	5-99
FUNCTION: PRIMARY NUMBER	5-100
FUNCTION: BACKUP NUMBER	5-101
FUNCTION: ALARM NUMBERS	5-102
FUNCTION: PRIMARY ALARM NUMBER	5-103
FUNCTION: BACKUP ALARM NUMBER	5-104
FUNCTION: ENABLE/DISABLE CALL BACK	5-105
FUNCTION: ENABLE/DISABLE TRITON CONNECT	5-106
FUNCTION: ATM MONITORING	5-107
FUNCTION: STATUS MONITORING	5-108
FUNCTION: HEARTBEAT MESSAGE	5-109
FUNCTION: AD SCREENS	5-112
FUNCTION: COMMUNICATION HEADER	5-113
FUNCTION: MORE	5-114
FUNCTION: ALARM THRESHOLDS	5-115
FUNCTION: SET LOW CASH THRESHOLD	5-116
FUNCTION: SET JOURNAL THRESHOLD	5-117
FUNCTION: SET SCHEDULED JOURNAL	5-118
FUNCTION: VIEW/MODIFY OPTIONS	5-119
FUNCTION: ACTIVATE	5-120
FUNCTION: DEACTIVATE	5-121
FUNCTION: SELECT FEATURE NUMBER	5-122
FUNCTION: DATE/TIME FUNCTIONS	5-123
FUNCTION: SET DATE FORMAT	5-124
FUNCTION: SET DATE / TIME	5-125
FUNCTION: SET DATE	5-126
FUNCTION: SET TIME	5-127

CONTENTS

FUNCTION: TRANSACTION TYPES	5-128
FUNCTION: ACCOUNT TYPES	5-129
SECTION 6 - MAINTENANCE	6-1
CLEANING THE ENCLOSURE	6-2
CLEANING THE DISPLAY	6-2
CARD READER MAINTENANCE	6-2
REPLENISHING THE RECEIPT PRINTER	6-3
SECTION 7 - JOURNAL ENTRIES	7-1
JOURNAL ENTRIES	7-2
SECTION 8 - ERROR RECOVERY	8-1
INTRODUCTION	8-2
ERROR RECOVERY	8-2
RESETTING THE CASH DISPENSER	8-3
MAKO DISPENSER ERROR CODES	8-4
MISCELLANEOUS ERROR CODES	8-4
SECTION 9 - CUSTOMER TRANSACTIONS	9-1
INTRODUCTION	9-2
CUSTOMER TRANSACTIONS	9-2
WITHDRAWAL TRANSACTION	9-3
TRANSFER TRANSACTION	9-4
BALANCE INQUIRY TRANSACTION	9-5
APPENDIX A - MECHANICAL COMBINATION LOCK INSTRUCTIONS	A-1
ABOUT THE DIAL	A-2
UNLOCKING 3-NUMBER COMBINATIONS	A-2
To Lock	A-2
CHANGING THE COMBINATION	A-3
APPENDIX B - ELECTRONIC COMBINATION LOCK INSTRUCTIONS	B-1
ENTERING COMBINATION	B-2
CHANGING COMBINATION	B-2
LOCKOUT FEATURE	B-2
BATTERY REPLACEMENT	B-2
APPENDIX C - WARRANTY AND REPAIR POLICIES/PROCEDURES	C-1
PARTS-ONLY LIMITED MANUFACTURER'S WARRANTY	C-3
DISCLAIMER OF WARRANTIES	C-3
SHIPPING DAMAGE	C-4
AUTHORIZED INSTALLATION AND SERVICE PROVIDERS	C-4
TRITON'S TECHNICAL SERVICES DEPARTMENT	C-5
CONTACT INFORMATION	C-6
INDEX	I-1

SECTION 1
INTRODUCTION

SECTION 1 - INTRODUCTION

WHAT'S IN THIS MANUAL

This manual describes all operating features of the Mako Cash Dispenser. It is divided into nine Sections and three Appendixes, which together provide the information necessary to setup and operate the unit. A brief description of each of these sections of the manual is provided below:

Section 2 - Features

This Section summarizes the major features and capabilities of the Mako Dispenser.

Section 3 - Operation and Setup

This Section covers initial setup of the various operating parameters of the Mako Dispenser.

Section 4 - Handling Cassettes

This Section shows how to remove, fill, and replace the dispenser's note cassette.

Section 5 - Management Functions

This Section provides extensive coverage of Management Functions, which enable you to setup, configure and control the operation of the dispenser's many operating features.

Section 6 - Maintenance

This Section describes the procedures for cleaning the unit and replenishing the receipt paper.

Section 7 - Journal Entries

This Section describes the parts of a typical journal entry. Journal entries are stored summaries of customer transactions and changes to the machine's operational state.

Section 8 - Error Recovery

This Section addresses error recovery and provides short descriptions of various error conditions that may be encountered, along with recommended corrective actions in many cases.

SECTION 1 - INTRODUCTION

Section 9 - Customer Transactions

This Section provides diagrams which illustrate the sequence of actions and screen displays associated with Withdrawal, Transfer and Balance Inquiry transactions.

Appendix A

This Appendix provides instructions for opening and changing the combination of the mechanical combination lock. This lock is the standard locking device for the Mako security vault, which holds the cash dispensing mechanism.

Appendix B

This Appendix provides instructions for using the optional electronic combination lock, which can replace the mechanical lock on the security vault.

Appendix C

This Appendix provides warranty and Triton Technical Support contact information.

NOTE: If the Dispenser you are using does not have the ability to perform some of the functions described in this manual, it is because your *processor* does not support the feature or the Mako Dispenser was purchased without that particular option installed.

In this manual, the terms *Mako*, *Mako Dispenser*, *Cash Dispenser*, *Dispenser*, or *Terminal* are used interchangeably.

WHAT IS MAKO?

Mako offers your customers the standard services commonly available from an Automatic Teller Machine (ATM), such as cash withdrawals, transfer of funds between accounts, and balance inquiries. However, it does not offer a deposit option.

Once a withdrawal has been completed, the transaction processor (the organization that handles the connection between the terminal and the banking system “network”) automatically debits the customer’s account. The processor credits the merchant’s account for the amount of the withdrawal plus any surcharge (if applicable) at the end of the business day.

As is typically the case with non-bank (“retail”-style) ATMs, the Mako ATM does not accept cash deposits.

SECTION 1 - INTRODUCTION

BALANCING DAILY TRANSACTIONS

Mako keeps track of all transactions and provides simple printed reports to assist in maintaining accurate balance records. The DAY CLOSE function, for example, summarizes the transaction activities of the previous business day. The CASSETTE CLOSE function summarizes the activities since the cash-dispensing cassette was last loaded.

The exact details of the closing procedure vary slightly, depending upon the sponsoring network. The closing procedures that are applicable in most cases are described in detail in Section 5, Management Functions.

SECTION 2
FEATURES

SECTION 2 - FEATURES

MAKO CASH DISPENSER

The general features of the Mako Cash Dispenser are described in Table 2-1:

Table 2-1. Mako Cash Dispenser Features.

- UL approved.
- Uses an ordinary dial-up telephone line, instead of an expensive leased line.
- 2400 bps (bits-per-second) modem standard (optional 14400 and 33600 bps modems available).
- Cassette holds approximately 1000 new/750 used US currency notes.
- Escrow compartment holds rejected notes for safekeeping and ease of accountability.
- Reliable friction-feed, positive-drive cash dispensing mechanism.
- Electronic journal can store up to 2045 of the most recent transactions for later printout.
- Intuitive, user-friendly keypad and display interface.
- 320 x 240 dot resolution gray-scale (16 shades of gray) backlit Liquid Crystal Display (LCD). Optional Color LCD display available.
- Flush-mounted magnetic dip-style card reader.
- Fixed-head thermal printer designed for quiet operation.
- Modular design for ease of maintenance.

Figure 2-1 shows the Mako Cash Dispenser.

NEW FEATURES

The version 4.1 release of terminal operating software provides significant enhancements to the capabilities of the Mako Cash Dispenser. These new features are summarized in the following paragraphs.

- ***Improved Monochrome Graphic Display Support***

The rendering of gray-scale images has been improved significantly. The availability of a more life-like rendering of monochrome graphics can make the use of these images a more appealing option in certain applications.



Figure 2-1. Mako Media Dispenser.

SECTION 2 - FEATURES

- **256-Color Ad Graphic Display Support**

ATM Software Release 4.1 delivers support for the new 256-color display feature of Triton Systems ATMs. Ad Graphic screens can now be displayed using a richer palette of 256 colors.

- **MAC Data Encryption Support**

ATM Software Release 4.1 implements support for the Message Authentication Code (MAC) data encryption protocol. This capability is typically referred to as “MAC-ing”. **NOTE: This feature is currently only available in the Triton Standard version of ATM Software Release 4.1. Also, the SPED option (described below) is required to support MACing.**

MACing Provides increased protection for message traffic to and from the ATM.

- **SPED PIN Entry Device Support**

The newest ATM EPROM upgrade, along with Software Release 4.1, support an optional feature of Triton Systems ATMs known as the Secure PIN Entry Device, or SPED. Note that the SPED option is required in order to support MACing. SPED is an encryption system that offers additional protection for the customer PIN during entry at the ATM keypad.

- **DATAPAK 3000 Communications Protocol Support**

ATM Software Release 4.1 is DATAPAK 3000 protocol-compliant. This new capability enables the ATM to interface with designated DATAPAK intermediaries (in the Canadian market region), who in turn provide connectivity to the appropriate transaction processor. **NOTE: This feature is only available for use in the Canadian market.**

DATAPAK 3000 connectivity is typically faster and more cost-effective than a direct dial-up connection between the ATM and the transaction processor.

STANDARD FEATURES

The standard operating features of the Mako Cash Dispenser are summarized in the following paragraphs.

- **Close Scheduling**

This function enables the operator to establish a time at which the terminal will automatically initiate a close operation with the processor. If only manual initiation of a close is desired, this feature can be turned off.

SECTION 2 - FEATURES

- ***Exit Message***

This feature allows a message to be displayed to the customer at the conclusion of a transaction. The content of the message is determined by the operator.

- ***Predial Capability***

By initiating the call to the processor immediately after the customer inserts and removes their ATM or credit card (predialing), the actual transaction, once selected, can be completed more quickly. If desired, the predial capability can be disabled, in which case the call to the processor will not be made until after the customer actually chooses a transaction.

- ***Alarm Thresholds***

NOTE: This feature must be used in conjunction with Triton Connect version 3.0 or later.

This feature enables the terminal to detect and automatically report the following conditions to a remote personal computer (PC) that is running Triton Connect (version 3.0 or later):

- 1.) The level of cash in the cassette has fallen below a pre-defined threshold.
- 2.) The number of journal entries has risen above a pre-defined threshold.

In addition, a journal transfer feature allows the terminal to automatically transfer the contents of the electronic journal to the Triton Connect PC.

- ***Transaction and Account Type Configuration***

This feature enables the terminal operator to select the types of transactions (transfers or balance inquiries) or accounts (savings or credit card) that will be presented to the customer. This feature does not affect the availability of withdrawal transactions from checking accounts, which are always presented.

- ***Electronic Journal***

The Mako Dispenser features a solid state electronic journal, instead of the traditional mechanical journal printer. The electronic journal is based on proven Triton technology and provides improved reliability and ease of use.

The details of each transaction are stored in the journal's memory, and can be retrieved at a later date. When needed, just the information desired can be recalled and a printout of the records made.

SECTION 2 - FEATURES

Normally, journal data is printed by the unit's receipt printer, but with the optional Triton Connect software package the information can be sent to a remote PC (Personal Computer) for storage and subsequent analysis.

The information in the electronic journal is maintained in a safe and secure environment. The journal is physically located in the lower security compartment of the unit, making it as secure as the cash itself. Even after a transaction record has been printed to the receipt printer, it can still be read and printed again. Old records are retained in the electronic journal until 2045 records have been stored, at which time the journal must be printed or cleared.

The software on the terminal makes it easy to retrieve stored information as often as necessary. From the operator's standpoint, use of the journal is simple. All that is required of the operator is to do a *PRINT JOURNAL* command on a regular basis. Typically, the journal should be printed out whenever a *DAY CLOSE* is completed, although this is not a requirement.

When the *PRINT JOURNAL* command is selected, only the records acquired since the last *PRINT JOURNAL* command will be printed. Therefore, you don't have to keep track of what record was printed last, because the terminal does it for you.

If the printed copy of a group of records is accidentally lost or destroyed, or the receipt printer runs out of paper before completely printing a group of records, it is a simple matter to reprint them, since they remain stored in the journal (until overwritten, as explained earlier).

- ***Distributor EPROM Access With Challenge***

This feature provides increased security by allowing each distributor to select their own unique EPROM access code for each terminal they sell or service. Procedures for entering and changing the EPROM Access Code are contained in the Mako Dispenser Installation and Service Manual.

- ***Status Monitoring***

This feature (not available with all versions of the terminal's operating software) allows information about the operational status of the terminal to be provided to the processor. The feature is activated using the terminal's Management Functions.

- ***Language Option***

The Mako Dispenser has a screen language option. This option allows the terminal user to select a preferred language (such as Spanish) when beginning an ATM transaction.

SECTION 2 - FEATURES

- ***International Monetary Support***

This feature allows installation and service personnel to select one of a number of monetary symbols (such as C, ¢, \$, f, L, P_t, £, Q, ¥) that describe the type of currency that will be dispensed by the Mako Dispenser. The default symbol can be viewed and changed through the Management Functions.

- ***Six-Digit Amount Entry Fields***

U.S. domestic versions of the terminal operating software allow up to six digits to be entered in all fields where a cash amount is expected. Some international versions of the software allow extended field-lengths (see Extended Fields).

- ***Receipt Printer Paper Low Option***

This feature allows the end user to determine whether or not the terminal is allowed to continue processing transactions when the receipt printer paper is low or the printer has run completely out of paper.

- ***Graphics Memory***

All Mako terminals with monochrome displays include 512 kilobytes (KB) of “flash” type memory, which can be used for the storage of Ad and/or printer graphics. Terminals with color displays come with 1.5 megabytes (MB) of memory (standard), but can be upgraded in 512 KB increments, to a maximum of four megabytes.

Formatting Memory

Graphics Memory is formatted so that it is ready to accept downloaded files from a Triton Connect Host Computer. The memory is initially factory formatted. If it becomes necessary to format the memory, it can be accomplished by two methods.

****CAUTION****

Formatting Graphics Memory will erase all stored graphics files. Do not format the memory unless you are certain you wish to erase all data stored in it!

SECTION 2 - FEATURES

Formatting Graphics Memory from a Triton Connect Host Computer

The first method uses Triton Connect to send a message to the terminal from the Triton Connect Host Computer that tells it to format Graphics Memory.

Formatting Graphics Memory at the Local Terminal

Graphics Memory can also be formatted from the local terminal through the Management Functions. Refer to the section on Management Functions for procedures.

- **AD Screens**

An Ad Screen is a promotional or advertising graphic that is displayed on the Mako Dispenser LCD screen. It is displayed alternately with the Customer Welcome screen graphic (while the terminal is idle) and while a customer transaction is being processed. Triton Connect Software Release 1.8 or higher is required to support the use of AD Screens.

Triton Connect has the ability to format 16-bit color graphics for use in AD Screens (this requires the optional 16-color LCD display), to format monochrome graphics for use in receipt printouts, and to create text-based messages.

Once formatted, the graphics and text-based messages can be downloaded to a terminal by the Triton Connect host computer. The time of day a specific Ad Screen is displayed and the duration it will be displayed can also be controlled.

- **Text-Based AD Screens**

Text-based AD Screens can be displayed to the customer while the terminal is performing a transaction. A maximum of four text-based ads can be displayed during the interval that the “Transaction Processing - Please Wait” message screen is being shown to the customer.

Each ad consists of up to eight lines of text, and each ad can be displayed for an operator-specified duration. The messages are created and downloaded to the terminal using Triton Connect Software Release release 1.8 or above.

SECTION 2 - FEATURES

- **Receipt Printer Graphics**

Triton Connect Software Release 1.8 or higher allows a bit-mapped graphic image in “.bmp” format to be downloaded to the terminal. This graphic is printed on the receipt when the PRINTED GRAPHIC option is enabled through the Management Functions.

- **Prize Coupons Option**

The Mako Dispenser may be configured to award “prize coupons” to customers on a random chance or a withdrawal amount-determined basis. Coupons are awarded as printed messages presented to the customer on a separate receipt. The messages consist of four lines of text, with up to 40 characters in each line. The text of the message is entered from the terminal’s keypad.

There are two methods of awarding coupons. The RANDOM approach awards coupons randomly within a specified percentage range (such as 3% of transactions) set in the management Functions.



Figure 2-6. Prize Coupons.

The LEVEL approach awards a coupon to each customer that withdraws an amount equal to or greater than a specific dollar value that is set in the Management Functions.

When a coupon is awarded, the Mako Dispenser beeps a distinctive tone, displays a message to alert the customer and prints a coupon after the money is dispensed (but before the customer receipt is printed). The prize coupon is printed on a separate receipt and a full cut is made between the coupon and the customer receipt.

- **Receipt Option**

This feature allows the operator of the Mako Dispenser to provide customers with the option of whether or not to receive a receipt after completing a transaction. The factory default for the RECEIPT OPTION is disabled, meaning a receipt will always be issued after each transaction (the customer *does not* have the option to choose).

If the RECEIPT OPTION is enabled, the customer is given the option of choosing to receive or not receive a printed receipt at the end of the transaction. If the customer fails to make a receipt choice, the receipt will be printed automatically after a 40- second time out period has elapsed.

SECTION 2 - FEATURES

- ***Color Display Option***

The Mako Dispenser can be equipped with an optional 16-color LCD display. As with the standard gray-scale display, the customer is guided through a transaction by selecting various options from menus that are presented on the LCD. Additionally, the terminal has the capability of displaying promotional information (AD Screens) in color while it is idle or when the customer is waiting for a transaction to be completed.

- ***Triton Connect™***

Triton Connect is an optional software package available through your service provider that facilitates remote data retrieval and monitoring of your Triton Systems Mako Dispenser. The advantages of this feature are reduced service calls and simplified terminal configuration changes, which in turn provides more imcashte and economical service for you.

The Triton Connect software runs on a remote host computer, and uses standard dial-up telephone lines to access and monitor the terminal. Triton Connect operates by dialing up the terminal and retrieving its data.

The Triton Connect host computer can monitor your Mako Dispenser 24 hours a day, seven days a week, and can receive an incoming call *from the Mako Dispenser* if there is a system error or service is required.

The Terminal Configuration options in the Management Functions area enable you to activate or deactivate Triton Connect access to the terminal.

Key information about the status of the terminal is collected and stored at a central location by your service provider. With this data, customer transaction reports can be developed that make it easy to monitor your Mako Dispenser's performance, schedule cash replenishment, and provide instant status for service dispatch should a problem occur.

- ***Extended Amounts***

The standard length of a currency amount entry field is 6 characters in U. S. domestic versions of the terminal operating software. In some international applications this length is insufficient to allow the entry of the full range of monetary values available in the local currency type. The Extended Amounts feature allows the selection of 12-character currency amount entry fields for those applications that require it.

SECTION 2 - FEATURES

Once selected, the Mako Dispenser can accept the entry of extended amounts for customer withdrawal and transfer transactions. The feature is activated using the terminal's Management Functions.

- ***Date/Time Format***

This option allows the operator to select either MM/DD/YY or DD/MM/YY as the format the terminal will use when printing receipts and other reports.

- ***Year 2000 Compliance***

The Mako Cash Dispenser has been tested to be 100% Year 2000 compliant.

Data Content/Integrity

Triton Cash Dispensers obtain date information from two sources: an internal clock, and the transaction processor or switch.

The internal clock is implemented by a Real Time Clock (RTC) integrated circuit. This device stores the year as a two-digit number (e.g. 1999 is stored as '99'). It will correctly roll from '99' to '00' at midnight on December 31, 1999. The software on the Cash Dispenser uses the date information solely for date/time stamping purposes on reports produced by the ATM. No calculations are performed using date arithmetic that would be adversely affected by the interpretation of '00' as 1900 instead of 2000. All reports that include a date are printed in the format MM/DD/YY or DD/MM/YY, as selected via Management Function control.

The date supplied by the processor or switch is also provided in the format that implements the year as two digits (either MM/DD/YY or YY/MM/DD, depending on the individual processor). This date is only used for date/time stamp purposes.

Data Content/Integrity

All date fields will remain as two digit representations, with the understanding that '00' will refer to the year 2000. No fields are to be expanded, either for storage or printing purposes.

Processor/Switch Compatibility Issues

While Triton has tested its own products and software to ensure compatibility with the Year 2000 change, it is not certifying the capability of the processors or switches that drive its terminals to handle the change.

SECTION 3
OPERATION AND SETUP

SECTION 3 - OPERATION AND SETUP

BASIC OPERATION

This chapter describes the basic operation and setup of the Mako Dispenser.

MENU-BASED OPERATION

The Mako Dispenser operates as a menu driven system. Messages and menu options presented on the LCD display screen guide the user's actions. The desired menu option is selected by pressing one of the screen keys located to the left and right of the display (see Figure 3-2). For the purpose of security many screens *timeout* after a preset time interval, usually 30 seconds. The timeout length may vary depending on the function being performed.

When a screen timeout occurs, a screen is presented which asks the user if more time is needed. If the user chooses NO, the Customer Welcome screen will be presented. If YES is chosen, the user is returned to the function that was active prior to the timeout. If the user does not make a selection within an additional 30-second countdown period the Mako Dispenser will automatically go to the Customer Welcome screen.

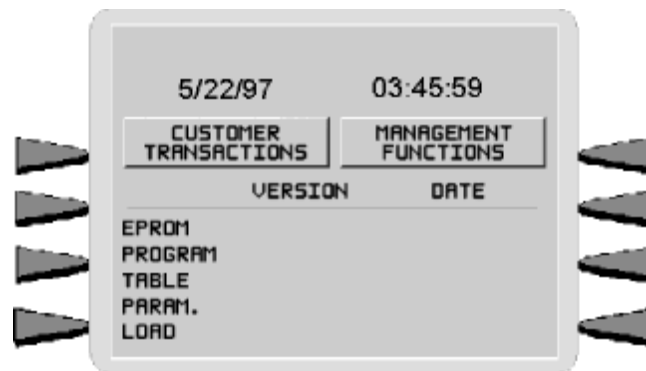

Figure 3-1. The TOP MENU display.

When the unit is turned on, the dispenser will beep once and the Top Menu, shown in Figure 3-1, will appear on the display screen after a few seconds. From the Top Menu, you can either:

- 1.) Activate the Mako Dispenser to perform customer transactions by pressing the key next to CUSTOMER TRANSACTIONS.
- 2.) Enter the Mako Dispenser system management area by pressing the key next to MANAGEMENT FUNCTIONS.

SECTION 3 - OPERATION AND SETUP

If you do not select a menu choice within 30 seconds the Mako Dispenser will automatically default to the Customer Welcome screen (a benefit of this feature is that in the event of a power interruption the terminal will automatically begin accepting customer transactions shortly after power is restored).

KEYPAD OPERATION

The user interface of the Cash Dispenser consists of the LCD display and 24 rubber keys on three keypads. The primary menu navigation keys are arranged in two four-key groups, one group on either side of the LCD display. The main keypad consists of 10 alphanumeric keys, two arrow keys and four large control keys, all located in a 16-key group beneath the LCD display.

All of the keys that a customer would use to conduct transactions have an integral raised Braille symbol to conform to the requirements of the Americans with Disabilities Act. To activate a key, press it until a beep is heard. If the key does not beep, it means that the key is not active for the current function, or the key was not pressed firmly enough.

The entry of numeric characters via the keypad is straightforward: simply press the desired key. However, in certain management function screens it may be necessary to enter alphabetic characters, a procedure that requires a little more explanation. On such screens a flashing cursor will be evident on the display, representing the location where the next character you enter will be displayed. To enter a letter or punctuation mark, you will first press the <BLUE> key, and then you will press the number that has the letter or other character you want.

Each of the numbered keys (<0> through <9>) has *six* characters available. See Figure 3-3, Alphanumeric Keypad, and Table 3-1, Keypad Characters. On most of these keys (<2> through <9>), the first three of the available characters are alphabetic, and are printed on the keycap above the number character. Two keys, the <0> and <1>, are different. The <0> key does not show any additional characters, while the <1> key shows two alphabetic characters ('QZ').



Figure 3-2. Cash Dispenser Keypad.

SECTION 3 - OPERATION AND SETUP



Figure 3-3. Alphanumeric Keypad.

KEYPAD CHARACTERS						
	X1	X2	X3	X4	X5	X6
1	Q	Z	Space	~	!	@
2	A	B	C	#	\$	%
3	D	E	F	^	*	-
4	G	H	I	()	
5	J	K	L	\	/	"
6	M	N	O	;	:	' Single Quote (Open)
7	P	R	S	?	<	>
8	T	U	V	[]	ñ
9	W	X	Y	{	}	' Single Quote (Close)
0	,	.	-	&	=	+

Table 3-1. Keypad Characters.

The first character *on the first key (0-9) you press after the <BLUE> key* will be displayed at the current cursor position. Pressing the same key repeatedly will cycle the displayed letter through the available character choices for that key (X1-X6). When the desired character is displayed, press the <RIGHT ARROW> key to 'lock it in' and move the cursor to the next position. Repeat these steps to enter the next character.

SECTION 3 - OPERATION AND SETUP

The <RIGHT ARROW> and <LEFT ARROW> keys are used in most alphanumeric data entry situations. The <LEFT ARROW> is used to back up and erase a character. The <RIGHT ARROW> is used to lock in a character. These keys will auto-repeat if held down for more than one second.

The <CHANGE> key can be used to clear an entry and start over. The <CANCEL> key will abort the current transaction.

The keys located beside the display are called the Screen Keys. They are used in the selection of menu functions. A Screen Key is only active when a function or menu option name is displayed beside the key.

CHANGING TO MANAGEMENT FUNCTIONS

You can enter the terminal MANAGEMENT FUNCTIONS main menu screen by performing any one of the three procedures listed below:

1. The Customer Welcome screen shows an animation of a hand inserting and removing a card, with a message describing how to begin a transaction. If this screen is being displayed, press and hold down the <BLUE> key; while holding down the <BLUE> key, press the <1> key. Release both keys. After a moment the Top Menu screen (shown in Figure 3-1) will be displayed. Select the MANAGEMENT FUNCTIONS option.
2. Reset the Dispenser by pressing and releasing the Reset Switch found on the front panel of the Memory Module, which is located in the card cage inside the upper enclosure of the terminal. When the Top Menu is displayed select MANAGEMENT FUNCTIONS.
3. Remove and then reapply power to the terminal using the ON/OFF switch located on the right side of the card cage inside the upper enclosure of the terminal. When the Top Menu is displayed select MANAGEMENT FUNCTIONS.

The Top Menu allows you to choose one of two options, CUSTOMER TRANSACTIONS or MANAGEMENT FUNCTIONS. Selecting CUSTOMER TRANSACTIONS changes the display to the Customer Welcome screen so the Dispenser is ready to perform customer transactions. Selecting MANAGEMENT FUNCTIONS opens the password screen, which in turn provides access to menus that are used for changing or viewing terminal parameters.

Whenever the MANAGEMENT FUNCTIONS choice is selected, the Dispenser will ask for a password to be entered. For a first-time configuration, enter the default MASTER PASSWORD of '123456' on the keypad and then press the <OK> key. This 'default' password will be valid until it is changed.

SECTION 3 - OPERATION AND SETUP

****NOTE****

The operator of the Mako Dispenser must change the MASTER PASSWORD to a new number when the installation is complete.

The Top Menu serves an alternative purpose in the event of a machine malfunction or other error condition. Such conditions are normally reported by an “OUT OF SERVICE” message screen. The typical response to this message is to reset the Cash Dispenser. After resetting the Cash Dispenser the Top Menu screen will display any applicable status messages and error code numbers.

The two options presented in such instances will be RESET ERROR and MANAGEMENT FUNCTIONS. Press RESET ERROR to attempt to clear the error, or enter the MANAGEMENT FUNCTIONS area, as desired. See Section 8, Error Recovery, for more information.

INITIAL MAKO DISPENSER CONFIGURATION

There are seven configuration parameters that must be set when a Mako Dispenser is installed. These parameters do not need to be set in any particular order, but they **MUST** be entered into the Mako Dispenser to enable customer transactions to take place. Once they are set, they are retained internally, even when the Mako Dispenser is turned off.

Detailed procedures describing the step-by-step setup of each terminal parameter are located in Section 5 of this manual.

- ***Terminal Number***

The TERMINAL NUMBER is a unique string of alphanumeric characters (numbers and/or letters) that identifies your Mako Dispenser to the processor. The TERMINAL NUMBER is assigned to your Mako Dispenser by your processor

The TERMINAL NUMBER and TELEPHONE NUMBER **MUST** be set before the Mako Dispenser can go on-line and before the *communications key* can be downloaded.

- ***Telephone Number***

The Mako Dispenser communicates to your host processor over a dial up phone line. The phone number of the processor must be entered before live transactions can be performed.

SECTION 3 - OPERATION AND SETUP

- **Surcharge Mode**

Some networks allow a surcharge, or terminal fee, to be imposed on withdrawal transactions. If surcharges are in use on your network, you are required to notify the customer of the possibility of an additional fee before the transaction is processed. The customer must be given a chance to cancel the transaction.

Setting the SURCHARGE MODE to ENABLED will cause the surcharge warning screen to be displayed after the customer's card is inserted. The surcharge warning screen notifies the customer of a possible fee and its amount. The customer is given the opportunity to cancel the transaction at no charge or to accept the surcharge and continue with the transaction.

If your network does not allow surcharges, the SURCHARGE MODE must be set to DISABLED.

The amount of the surcharge is stored in the Dispenser and displayed to the customer. The SURCHARGE AMOUNT displayed on the screen can be set manually via the SURCHARGE AMOUNT menu. In some cases this value is downloaded from the processor at the same time the communications key is downloaded.

Manually changing the SURCHARGE AMOUNT to a different value does not automatically change the surcharge collected by the processor for a transaction. *It will only change the surcharge in the surcharge-warning message shown to the customer and NOT the actual fee collected for the transaction, so be sure the values are the same AND are accurate!*

- **Multiple Amount**

This is the value of the denomination of the cash in the currency cassette. It must be set to a value that is *at least 1/20th of the MAXIMUM AMOUNT*. For example, if the MAXIMUM AMOUNT is 200.00, then the MULTIPLE AMOUNT must be at least \$10.00 (\$20.00 would also work).

The factory default for the MULTIPLE AMOUNT is \$0.00.

SECTION 3 - OPERATION AND SETUP

- ***MAC Master/Working Keys***

The MAC MASTER KEY is used to decrypt the MAC WORKING KEY. Each key is a 16-character string, consisting of a combination of the digits 0-9 and the letters A-F. The MAC MASTER KEY may be injected from a personal computer (using a special floppy disk), or entered manually at the keypad.

- ***PIN Master/Working Keys***

The PIN MASTER KEY is used to decrypt the PIN WORKING KEY. The PIN WORKING KEY was referred to in previous versions of ATM software as the COMMUNICATIONS (COMMS) KEY. Each key is a 16-character string, consisting of a combination of the digits 0-9 and the letters A-F. The PIN WORKING KEY may be entered manually or downloaded from the processor.

ADDITIONAL PARAMETERS

In addition to the configuration parameters described in the previous paragraphs, there are several other parameters that will need to be entered into the Dispenser to complete its setup. The procedures for setting each of these parameters are found in Section 5 of this manual. Some parameters are processor-specific and may not be available for all locations.

- ***Maximum Amount***

The maximum withdrawal limit must be entered into the Dispenser before any transactions can be completed. This number is the largest dollar amount allowed for a single withdrawal transaction. The MAXIMUM AMOUNT may be set from \$1 to \$999 in increments of \$1 and must be set to a multiple of the denomination of the currency in the cassette. Factory default is set to \$500.00. The value must be a whole dollar amount only.

Whenever a withdrawal transaction is processed, the amount entered or selected is compared to the MAXIMUM AMOUNT parameter. If the entry is larger, an error message warns the user and displays the maximum allowable amount. Additionally, *the MAXIMUM AMOUNT cannot be more than 20 times greater than the denomination of the currency in the cassette.*

The MAXIMUM AMOUNT entered into the Dispenser **DOES NOT** override any maximum set by a network. The transaction will be sent to the network if the amount entered or selected is less than the maximum. The network must still approve the requested amount.

SECTION 3 - OPERATION AND SETUP

- ***Store Message***

The Store Message consists of up to four lines of text that are printed at the top of each receipt and report. This message is typically used to print the store name, address and phone number.

- ***Marketing Message***

The Marketing Message consists of up to four lines of text that are printed at the top of each receipt and report. This message can be used for advertising purposes, sales notifications, promotions, or other purposes.

- ***Surcharge Owner***

The name of the surcharge owner is stored in the terminal and printed on the receipt.

- ***Terminal Owner***

The name of the Terminal Owner is stored in the terminal and displayed to the customer in the surcharge-warning message.

- ***Welcome Message***

The Welcome Message consists of three lines of text that are displayed on the Customer Welcome screen.

- ***Language Option***

This feature allows the terminal operator to select the language that is displayed to the customer during a transaction, as well as the language in which the Management Functions are presented. A feature is also provided that gives the customer the option of selecting a preferred language. Also, some terminal software versions allow receipts to be printed using the non-English language choice.

- ***Receipt Option***

This feature allows the customer to select the option of receiving or not receiving a receipt at the completion of a transaction.

SECTION 3 - OPERATION AND SETUP

- ***Coupon Options***

Coupons are used for promotional purposes. The owner of the Mako Dispenser can use the Coupon Options feature to issue printed coupons from the receipt printer. Coupons are issued randomly (based on percentage) or whenever a customer uses the Dispenser to withdraw more than a predetermined minimum amount of cash.

- ***Date/Time Format***

This option allows the operator to select either MM/DD/YY or DD/MM/YY as the format the terminal will use when printing receipts and other reports.

SETUP PARAMETERS

Table 3-2, Mako Setup Parameters, lists all of the operator-configurable parameters accessible through the Management Functions. References to the specific pages in Section 5, Management Functions, are provided to help quickly locate the description and applicable setup instructions for each parameter. In most cases the factory default value of each parameter is also provided.

Although many of the parameters have been set at the factory, it is important to verify that the settings are appropriate. Certain default values are merely ‘place holders’ and should be changed to reflect the actual settings and values required. Review the table and take the time to make the necessary changes and updates as needed to ensure the terminal is completely setup, customized for its intended application, and ready to operate.

SECTION 3 - OPERATION AND SETUP

MAKO SETUP PARAMETERS					
FUNCTION/PARAMETER	FACTORY DEFAULT	PAGE NO.	FUNCTION/PARAMETER	FACTORY DEFAULT	PAGE NO.
CLOSE			36	EXTENDED AMOUNT	DISABLED 5-71
1	SCHEDULE CLOSE	OFF 5-7	37	FAST CASH AMOUNT	* 5-72
2	CHANGE SCHEDULE	* 5-8	38	ENTER MAC MASTER KEY	* 5-74
3	SEND TERMINAL TOTALS	OFF 5-12	39	ENTER PIN MASTER KEY	* 5-76
4	ENTER QTY. IN CASSETTE	0 5-13	40	INJECT MASTER KEYS	* 5-78
DIAGNOSTICS			41	ENTER MAC WORKING KEY	* 5-79
5	MODEM SPEAKER ON/OFF	OFF 5-24	42	ENTER PIN WORKING KEY	* 5-81
LANGUAGE / IDIOMA			43	DOWNLOAD WORKING KEYS	* 5-83
6	ENGLISH/INGLES	* 5-27	44	PRIMARY NUMBER (TELEPHONE)	NONE 5-85
7	SPANISH/ESPAÑOL	* 5-28	45	BACKUP NUMBER (TELEPHONE)	NONE 5-86
8	ENABLE/DISABLE CUST. OPTION	DISABLED 5-29	46	DATAPAK ACCESS CODE	NONE 5-87
PASSWORD MAINTENANCE			47	PREDIAL ON/OFF	OFF 5-88
9	MASTER PASSWORD	123456 5-35	48	COMPUSERVE ID	* 5-89
10	ADMINISTRATION PASSWORD	987654 5-36	49	DIAL MODE	DTMF 5-91
PRINTER SETTINGS			50	DIAL RATE	FAST 5-92
11	SET PRINT LENGTH	35 5-37	51	BAUD RATE	1200 5-93
12	LOW RECEIPT PAPER	OFF 5-40	52	MODEM SETUP STRING	* 5-94
13	PRINTER GRAPHICS	ENABLED 5-41	MORE TERMINAL PARAMETERS		
RANDOM / LEVEL PRIZE COUPONS			53	ADJUST CONTRAST	* 5-97
14	ENTER LEVEL PRIZE MESSAGE	* 5-43	54	RECEIPT OPTION	DISABLED 5-98
15	ENTER RANDOM PRIZE MESSAGE.	* 5-44	55	PRIMARY NUMBER (TRITON CONNECT)	NONE 5-100
16	ENABLE/DISABLE COUPON AWARD	DISABLED 5-45	56	BACKUP NUMBER (TRITON CONNECT)	NONE 5-101
17	SET LEVEL PRIZE AMOUNT	\$0.00 5-46	57	PRIMARY ALARM NUMBER	NONE 5-103
18	SET RANDOM WINNING %	0% 5-47	58	BACKUP ALARM NUMBER	NONE 5-104
CHANGE MESSAGES			59	ENABLE/DISABLE CALLBACK	ENABLED 5-105
19	MARKETING MESSAGE	* 5-49	60	ENABLE/DISABLE TRITON CONNECT	DISABLED 5-106
20	SURCHARGE MESSAGES	* 5-50	61	STATUS MONITORING	DISABLED 5-108
21	WELCOME MESSAGE	* 5-52	62	HEARTBEAT MESSAGE	* 5-109
22	SURCHARGE OWNER	* 5-53	63	AD SCREENS	ENABLED 5-112
23	EXIT MESSAGE	* 5-54	64	ENABLE/DISABLE COMMUNICATION HEADER	DISABLED 5-113
24	STORE MESSAGE	* 5-55	65	CHANGE COMMUNICATION HEADER	* 5-113
25	TERMINAL OWNER	* 5-56	66	ALARM THRESHOLDS ON/OFF	OFF 5-115
SET TERMINAL PARAMETERS			67	SET LOW CASH THRESHOLD	* 5-116
26	SET TERMINAL #	NONE 5-58	68	SET JOURNAL THRESHOLD	* 5-117
27	SURCHARGE PERCENT	0% 5-61	69	SET SCHEDULED JOURNAL	* 5-118
28	LESSER/GREATER SELECTION	LESSER 5-61	70	VIEW/MODIFY OPTIONS	* 5-119
29	ENABLE/DISABLE SURCHARGE	DISABLED 5-62	TERMINAL CONFIGURATION		
30	SURCHARGE LOCATION	BEGINNING 5-63	71	SET DATE FORMAT	MM/DD/YY 5-124
31	BLOCK ISO'S	NONE 5-64	72	SET DATE	N/A 5-126
32	SURCHARGE AMOUNT	\$0.00 5-66	73	SET TIME	N/A 5-127
33	INTERNATIONAL CURRENCY	* 5-68	74	TRANSACTION TYPES	ON 5-128
34	MAXIMUM AMOUNT	\$500.00 5-69	75	ACCOUNT TYPES	ON 5-129
35	MULTIPLE AMOUNT	\$0.00 5-70			

*REFER TO SECTION 5, MANAGEMENT FUNCTIONS, FOR INFORMATION ON THE FACTORY DEFAULTS FOR THESE FUNCTIONS.

SECTION 4
HANDLING CASSETTES

SECTION 4 - HANDLING CASSETTES

MEDIA CONDITION

Documents loaded into the note cassette must be in “fit” condition if a high level of performance (low reject and failure rate) is expected from the Mako dispensing mechanism. “Fit” documents are defined as those that do not possess any of the defects listed below:

- **Used Currency**

“Fit” used currency does not possess any of the following defects:

- Sticky substances on the surface of the paper.
- Tears, holes, or missing sections in the body of the currency.
- Tape on the surface of the currency used for repairing, patching or any other purpose.
- Staples, pins, or any other foreign objects attached to the currency.
- Two or more sheets of currency joined by any means.
- Nearly new currency which has been excessively crumpled or crinkled.

- **New or Uncirculated Currency**

“Fit” new or uncirculated currency does not possess any of the following defects:

- All the conditions listed above for used currency.
- New or uncirculated currency must be “burst” and fully separated prior to loading into cassettes.

REPLENISHING CASSETTES

1. Open the security container via the enclosure lock on the front of the unit. Swing the door out to gain access to the dispenser mechanism, which is attached to the back surface of the door panel.
2. For security reasons the cassette is locked to the chassis of the dispenser mechanism. To unlock it, use the provided access key to disengage the locking mechanism. (See Figure 4-1.)

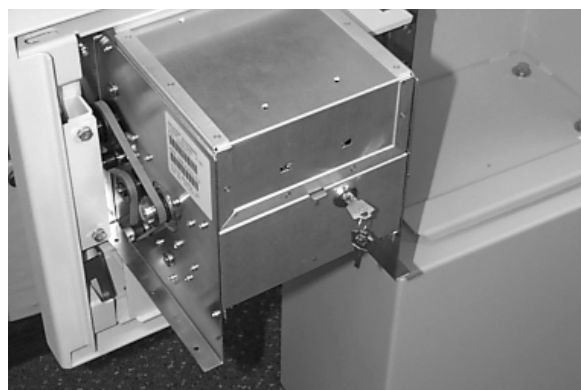

Figure 4-1. Unlock the cassette.

SECTION 4 - HANDLING CASSETTES

- Lift the cassette up slightly, so that its rear bottom edge lifts free of the two alignment pins on the top of the dispenser chassis. (See Figure 4-2.)



Figure 4-2. Lift cassette to clear the alignment pins.

- Pull the cassette out slightly, so that you can place your free hand around the front of the cassette opening. This is the feed end of the cassette. Apply pressure with your palm and curl your fingers around the bottom front edge of the cassette to prevent any remaining notes from falling out. Slide the cassette up and out of the dispenser chassis. (See Figure 4-3.)

If there are any notes remaining in the dispenser chassis, remove them by carefully pulling them from under the pickup wires. If necessary, turn the motor pulley manually to eject any notes lower in the feedpath.

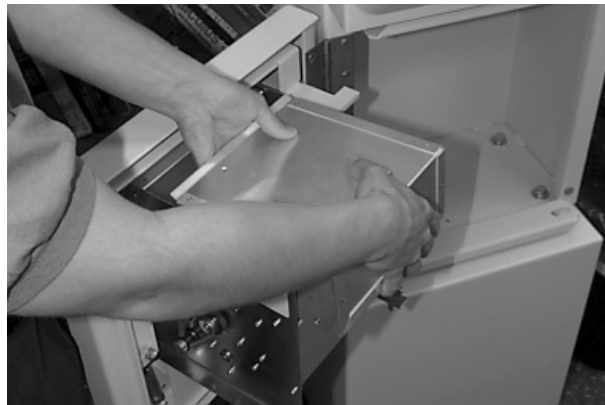

Figure 4-3. Lift cassette from dispenser chassis.

- Transport the cassette to a flat work surface. Remember to hold the cassette level, maintaining constant pressure to any existing notes to prevent them from falling out.



Figure 4-4. Hold notes during transport.

SECTION 4 - HANDLING CASSETTES

6. Place the cassette on a level, flat surface, oriented so that the feed opening is up, as in Figure 4-5. Place a small bundle of notes, approximately one inch thick, on top of the opening. If there are no notes already in the cassette, the bundle will rest on the spring pressure plate.

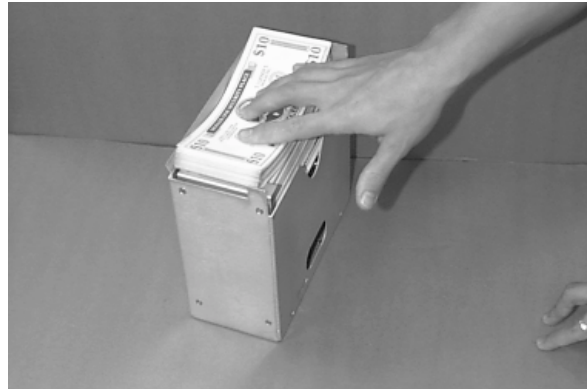

Figure 4-5. Place bundle of notes on top of feed opening.

7. Apply just enough pressure to the center of the bundle to overcome the spring action of the internal pressure plate, so that the bundle of notes is pushed into the cassette. Repeat Steps 6 and 7 to fill the cassette.

While holding the cassette as you did in Step 5, shake it slightly to level out the stacks of currency. Follow the next steps to return the cassette to the dispenser mechanism.



Figure 4-6. Press note bundle into cassette.

8. Lower the cassette back into the dispenser chassis at an angle and slide it forward. Remove your hand from the front of the cassette to allow it to slide completely forward. Keep the rear of the cassette raised slightly, as shown in Figure 4-7.



Figure 4-7. Slide/lower the cassette back into the dispenser chassis.

SECTION 4 - HANDLING CASSETTES

9. Lower the cassette onto the alignment pins.

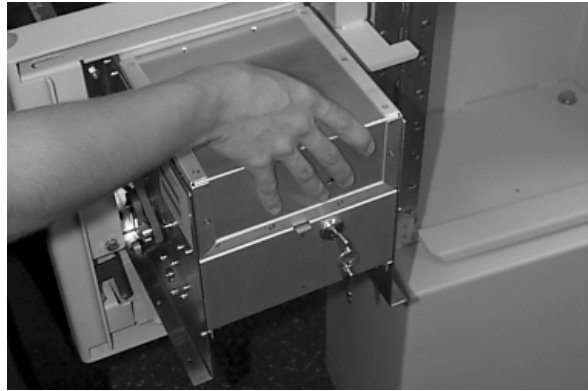

Figure 4-8. Lower cassette into final position..

10. Lock the cassette into the dispenser mechanism chassis. Remove the cassette locking key. Close the security container door and lock the security container.



Figure 4-9. Lock the cassette into the dispenser chassis..

SECTION 4 - HANDLING CASSETTES

THIS PAGE INTENTIONALLY LEFT BLANK.

SECTION 5
MANAGEMENT FUNCTIONS

SECTION 5 - MANAGEMENT FUNCTIONS

INTRODUCTION

This section describes the MANAGEMENT FUNCTIONS available for controlling the Cash Dispenser. When the CUSTOMER WELCOME screen is displayed, you can access the MANAGEMENT FUNCTIONS menu by following the procedure described next.

ACCESSING THE MANAGEMENT FUNCTIONS MENU

- 1.) Press and hold down the <BLUE> key; while holding down the <BLUE> key, press the <1> key. Release both keys. After a moment the Top Menu will be displayed.
- 2.) At the Top Menu (see figure to the right), select MANAGEMENT FUNCTIONS.

The TOP MENU Screen.

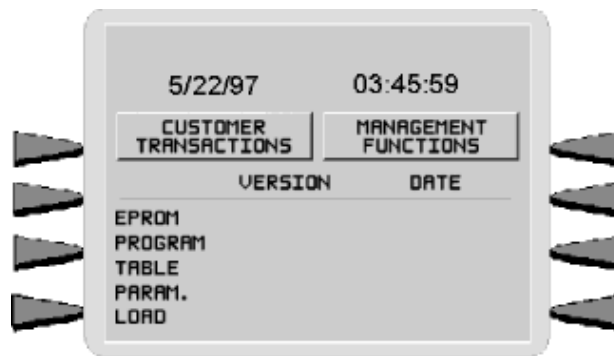

- 3.) Enter the MASTER or ADMINISTRATION password at the Password Entry display (see figure below). The factory default MASTER PASSWORD is '123456'. The factory default ADMINISTRATION PASSWORD is '987654'.

The PASSWORD entry screen.



When a valid password is entered, the MANAGEMENT FUNCTIONS menu (see the figure on the next page) will be displayed. Once you have entered the MANAGEMENT FUNCTIONS Menu you may perform any of the functions allowed by the type of password used.

SECTION 5 - MANAGEMENT FUNCTIONS

The MANAGEMENT FUNCTIONS Screen.

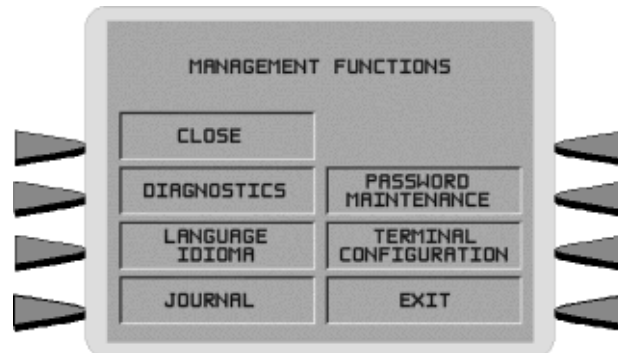

The ADMINISTRATION password allows access to a limited group of functions such as CLOSE, DIAGNOSTICS, etc. The MASTER PASSWORD allows access to all functions performed with the ADMINISTRATION password plus access to the Cash Dispenser configuration functions. Each MANAGEMENT FUNCTION description will include the function name, instructions for accessing the function, a factory default value (if applicable) and any error conditions associated with the use of the function.

FUNCTION AVAILABILITY

Some function screens or options described on the following pages may be present but not accessible on your Cash Dispenser. In these cases when you attempt to access the function you will receive a message informing you that the feature or hardware required to support it is not available.

In other cases a function screen or option described here may not even be present in the Management Functions for your particular Cash Dispenser. In such cases this is because the function is not available in the version of terminal operating software currently loaded in the unit.

You may also notice that the factory default values for some functions on your terminal may differ from the values shown in this manual. Again, this is because versions of the terminal operating software customized for a particular processor may require non-standard default values for some parameters.

MANAGEMENT FUNCTIONS CHART

The chart on the next page shows the organization of the various Management Functions. You can use this chart to quickly navigate to a particular function, or simply to see how functions are grouped and related together at different “levels” of the menu structure.

SECTION 5 - MANAGEMENT FUNCTIONS

FUNCTION: MANAGEMENT FUNCTIONS

FACTORY DEFAULT: N/A

ACCESS INSTRUCTIONS:

Select the MANAGEMENT FUNCTIONS option from the Top Menu (see page 5-2 for instructions on how to access the Top menu).

MANAGEMENT FUNCTIONS	
CLOSE	
DIAGNOSTICS	PASSWORD MAINTENANCE
LANGUAGE IDIOMA	TERMINAL CONFIGURATION
JOURNAL	EXIT

DESCRIPTION:

The MANAGEMENT FUNCTIONS menu allows the terminal operator to access the following functions:

- 1.) CLOSE
- 2.) DIAGNOSTICS
- 3.) LANGUAGE/IDIOMA
- 4.) JOURNAL
- 5.) PASSWORD MAINTENANCE
- 6.) TERMINAL CONFIGURATION

ERROR CONDITIONS:

There are no error conditions directly associated with this function.

SECTION 5 - MANAGEMENT FUNCTIONS

FUNCTION: CLOSE

FACTORY DEFAULT: N/A

ACCESS INSTRUCTIONS:

Select the CLOSE option from the MANAGEMENT FUNCTIONS screen to view the options available from the SELECT CLOSE FUNCTION menu.

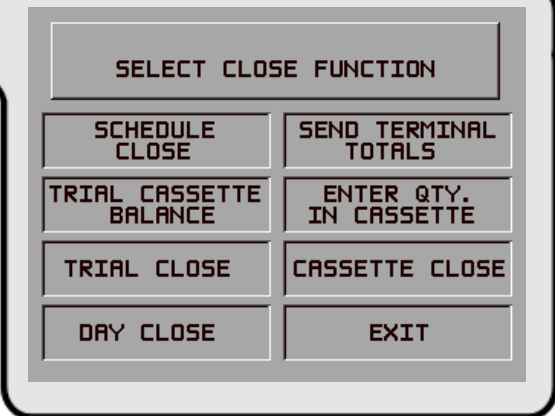

SELECT CLOSE FUNCTION	
SCHEDULE CLOSE	SEND TERMINAL TOTALS
TRIAL CASSETTE BALANCE	ENTER QTY. IN CASSETTE
TRIAL CLOSE	CASSETTE CLOSE
DAY CLOSE	EXIT

DESCRIPTION:

The SELECT CLOSE FUNCTION menu allows the terminal operator to perform the following functions:

- 1.) SCHEDULE CLOSE
- 2.) TRIAL CASSETTE BALANCE
- 3.) TRIAL CLOSE
- 4.) DAY CLOSE
- 5.) SEND TERMINAL TOTALS
- 6.) ENTER QTY. IN CASSETTE
- 7.) CASSETTE CLOSE

ERROR CONDITIONS:

There are no error conditions directly associated with this function.

SECTION 5 - MANAGEMENT FUNCTIONS

FUNCTION: SCHEDULE CLOSE

FACTORY DEFAULT: OFF

ACCESS INSTRUCTIONS:

- 1.) Select CLOSE from the MANAGEMENT FUNCTION screen.
- 2.) Select SCHEDULE CLOSE.

SCHEDULE CLOSE

SCHEDULE CLOSE OFF CHANGE SCHEDULE

EXIT

DESCRIPTION:

This function allows you to turn on or off the SCHEDULE CLOSE feature. It also provides access to the CHANGE SCHEDULE function, which allows you to specify the time of day when a CLOSE process will be automatically initiated (if the SCHEDULE CLOSE feature is turned ON). When the feature is turned OFF, the close procedure must be initiated manually.

The current state of the SCHEDULE CLOSE feature is shown as either ON or OFF in the label on the left-hand side of the display. Press the button next to this label to toggle the state of the feature between ON and OFF.

NOTE: The close information will be written to the Electronic Journal, allowing it to be printed out, or retrieved by a remote computer equipped with Triton Connect software (version 3.0 or later). Day Close reports initiated by this function will not be printed by the receipt printer.

ERROR CONDITIONS:

There are no error conditions directly associated with this function.

SECTION 5 - MANAGEMENT FUNCTIONS

FUNCTION: CHANGE SCHEDULE

FACTORY DEFAULT: N/A

ACCESS INSTRUCTIONS:

- 1.) Select CLOSE from the MANAGEMENT FUNCTION screen.
- 2.) Select SCHEDULE CLOSE.
- 3.) Select CHANGE SCHEDULE.

DESCRIPTION:

This function is used to set the time, in hours and minutes, at which the terminal will automatically initiate contact with the processor and perform a DAY CLOSE operation. The time is entered in the form 'HH:MM:SS' (hours, minutes, seconds). Do not enter the ':' characters separating the fields, just the fields themselves. Press CLEAR to erase everything and start over. Press the BACKSPACE key to back up and erase a single character. Press QUIT to escape without doing anything. Press SET TIME to load the entered time into the clock.

The Cash Dispenser will not let you enter an invalid number for hours or minutes. The clock will properly handle the rollover to the year 2000.

ERROR CONDITIONS:

There are no error conditions directly associated with this function.

SET DAY CLOSE TIME
DAY CLOSE TIME=
PRESS 2 FOR AM OR 7 FOR PM

BACKSPACE-->

HH:MM:SS XM

CLEAR-->

QUIT-->

SET TIME-->

SECTION 5 - MANAGEMENT FUNCTIONS

FUNCTION: TRIAL CASSETTE BALANCE

FACTORY DEFAULT: N/A

ACCESS INSTRUCTIONS:

- 1.) Select CLOSE from the MANAGEMENT FUNCTION screen.
- 2.) Select TRIAL CASSETTE BALANCE.

DESCRIPTION:

Selecting this function prints a receipt summarizing activity on the cassette since the last CASSETTE CLOSE was performed. The totals are not cleared (set to zero) or reported to the host during a trial cassette close.

The following information is provided:

- 1.) **START.** Includes the starting quantity of notes in the cassette, and the total value of this quantity.
- 2.) **DISPENSED.** Shows the number of notes that have been dispensed and the value of this quantity of notes.
- 3.) **REMAINING.** Shows the number of notes remaining in the cassette, and the total value of these notes.
- 4.) **VALUE OF EACH DOC.** The denomination of the notes in the cassette.
- 5.) **TRANSACTIONS.** The number of transactions that have occurred since the last.
- 6.) **REJECTS.** The number of reject events. Rejects can involve more than a single note per event.

ERROR CONDITIONS:

There are no error conditions directly associated with this function.

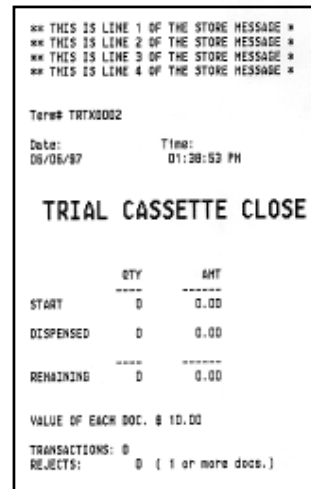
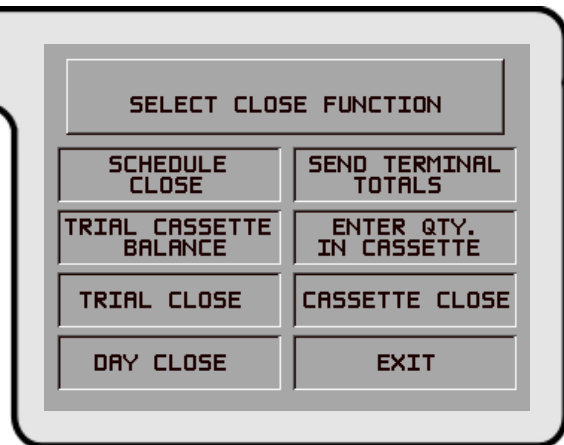

Sample TRIAL CASSETTE CLOSE receipt.

SECTION 5 - MANAGEMENT FUNCTIONS

FUNCTION: TRIAL CLOSE

FACTORY DEFAULT: N/A

ACCESS INSTRUCTIONS:

- 1.) Select CLOSE from the MANAGEMENT FUNCTIONS screen.
- 2.) Select TRIAL CLOSE.

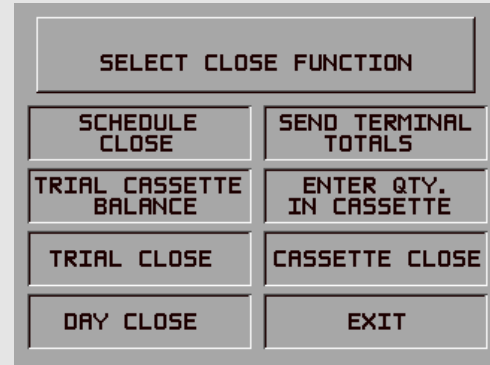

DESCRIPTION:

The TRIAL CLOSE function is used during the daily close procedure. It does the same thing as DAY CLOSE, except that the totals are not cleared.

The report printed by the TRIAL CLOSE is used to balance your Cash Dispenser before you actually balance with your processor. It contains information obtained from the processor and information that is obtained from the terminal itself.

Typically, you would do a TRIAL CLOSE to get the totals from the Cash Dispenser.

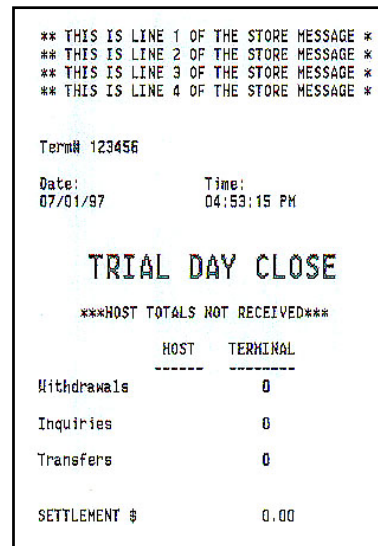

Sample TRIAL DAY CLOSE receipt.

The report shows the total number of customer transactions (Withdrawals, Inquiries and Transfers) recorded by the host processor and the terminal since the last Day Close was performed. The two-column format allows the host and terminal totals in each category to be easily compared. The 'Settlement \$' value is the host processor's record of the total currency dispensed from the terminal since the last Day Close was performed.

ERROR CONDITIONS:

A call to the processor host computer is required to complete the operation. If the call to the host is not completed successfully, a warning (**HOST TOTALS NOT RECEIVED**) will be printed on the report.

SECTION 5 - MANAGEMENT FUNCTIONS

FUNCTION: DAY CLOSE

FACTORY DEFAULT: N/A

ACCESS INSTRUCTIONS:

- 1.) Select CLOSE from the MANAGEMENT FUNCTIONS screen.
- 2.) Select DAY CLOSE.

SELECT CLOSE FUNCTION	
SCHEDULE CLOSE	SEND TERMINAL TOTALS
TRIAL CASSETTE BALANCE	ENTER QTY. IN CASSETTE
TRIAL CLOSE	CASSETTE CLOSE
DAY CLOSE	EXIT

DESCRIPTION:

The DAY CLOSE Function is used to complete daily balancing of the Cash Dispenser with the processor. The DAY CLOSE is performed to clear the totals and switch to the next business day. This function prints a report summarizing all of the activity done by the Cash Dispenser since the last DAY CLOSE was completed. The information includes a total of all transactions.

This function also calls your host processor's computer and commands it to download the totals it has accumulated for the current business day.

The DAY CLOSE is normally completed as the final step in the daily balancing process. The DAY CLOSE report is printed to the receipt printer. The TRIAL CLOSE function does the same thing as the DAY CLOSE, except that the totals are not cleared. See the TRIAL CLOSE function for more information.

NOTE: If the DAY CLOSE is not performed at the same time as the processors' day close, the host and terminal totals may not match.

ERROR CONDITIONS:

IA call to the processor host computer is required to complete the operation. If the call to the host is not completed successfully, a warning (**HOST TOTALS NOT RECEIVED**) will be printed on the report.

```

** THIS IS LINE 1 OF THE STORE MESSAGE *
** THIS IS LINE 2 OF THE STORE MESSAGE *
** THIS IS LINE 3 OF THE STORE MESSAGE *
** THIS IS LINE 4 OF THE STORE MESSAGE *

Term# TRTX0002
Date:      06/06/97      Time:      01:43:00 PH

DAY CLOSE

***HOST TOTALS NOT RECEIVED***

                TERMINAL
                -----
Withdrawals           0
Inquiries             0
Transfers             0
SETTLEMENT $         0.00

```

Sample DAY CLOSE receipt.

SECTION 5 - MANAGEMENT FUNCTIONS

FUNCTION: SEND TERMINAL TOTALS

FACTORY DEFAULT: OFF

ACCESS INSTRUCTIONS:

- 1.) Select CLOSE from the MANAGEMENT FUNCTION screen.
- 2.) Select SEND TERMINAL TOTALS.

DESCRIPTION:

This function allows you to turn on or off the REPORT TERMINAL TOTALS feature. When the feature is turned ON, the terminal will send accumulated totals information to the processor during the close operation. Terminal totals include the total value of all withdrawal, inquiry and transfer transactions that have occurred since the last close operation (see the description of the DAY CLOSE function for additional information).

The current state of the SEND TERMINAL TOTALS feature is shown as either ON or OFF in the label on the left-hand side of the display. Press the button next to this label to toggle the state of the feature between ON and OFF.

ERROR CONDITIONS:

There are no error conditions directly associated with this function.

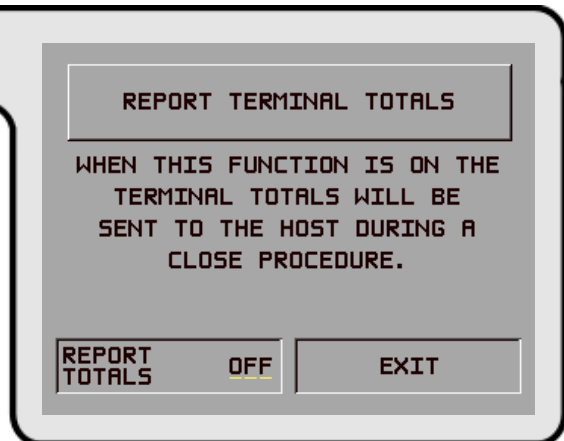

SECTION 5 - MANAGEMENT FUNCTIONS

FUNCTION: ENTER QTY. IN CASSETTE

FACTORY DEFAULT: '0'

ACCESS INSTRUCTIONS:

- 1.) Select CLOSE from the MANAGEMENT FUNCTION screen.
- 2.) Select ENTER QTY. IN CASSETTE.

ENTER THE NUMBER OF BILLS
THAT ARE IN THE CASSETTE NOW
(NOT THE VALUE)

AND THEN PRESS 'OK'

DESCRIPTION:

The ENTER QTY. IN CASSETTE function allows entry of the number of documents in the cassette. This number is used as a starting point for the cassette close report, the Dispense Counter value on the Receipt Printer Report and the Low Cash Threshold feature. Enter the total number of documents in the cassette and press <OK>.

NOTE: Enter the *number* of documents placed in a cassette, not the value of those documents.

ERROR CONDITIONS:

There are no error conditions directly associated with this function.

SECTION 5 - MANAGEMENT FUNCTIONS

FUNCTION: CASSETTE CLOSE

FACTORY DEFAULT: N/A

ACCESS INSTRUCTIONS:

- 1.) Select CLOSE from the MANAGEMENT FUNCTION screen.
- 2.) Select CASSETTE CLOSE.

DESCRIPTION:

The CASSETTE CLOSE function is used to complete the balancing of a specific currency cassette of the Cash Dispenser. This function prints a report summarizing all activity on the Cash Dispenser for the selected cassette since the last CASSETTE CLOSE was completed. The report includes a total of all transactions.

The CASSETTE CLOSE is normally completed as the final step in balancing the currency cassette before removing it to be replenished. The CASSETTE CLOSE report is printed to the Receipt Printer. Completing a CASSETTE CLOSE clears the cassette total from the Cash Dispenser.

NOTE: The Cassette Close operation also resets the number of bills loaded in the cassette to zero (0). After performing a cassette close, use the “ENTER QTY IN CASSETTE” function to enter the number of bills in the cassette.

ERROR CONDITIONS:

There are no error conditions directly associated with this function.

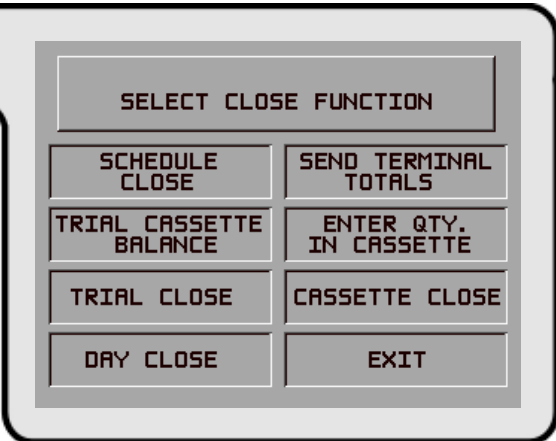

Sample CASSETTE CLOSE receipt.

SECTION 5 - MANAGEMENT FUNCTIONS

FUNCTION: DIAGNOSTICS

FACTORY DEFAULT: N/A

ACCESS INSTRUCTIONS:

Select DIAGNOSTICS from the MANAGEMENT FUNCTIONS screen.

DESCRIPTION:

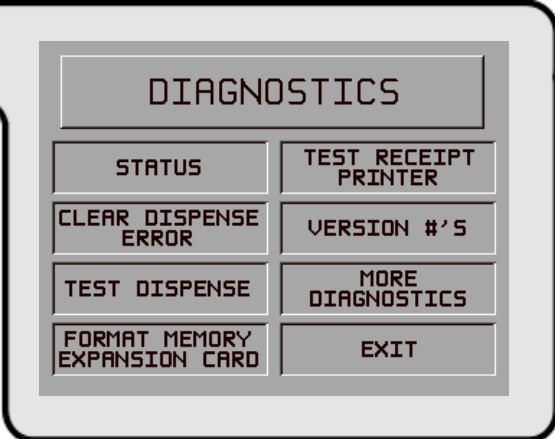

DIAGNOSTICS	
STATUS	TEST RECEIPT PRINTER
CLEAR DISPENSE ERROR	VERSION #'S
TEST DISPENSE	MORE DIAGNOSTICS
FORMAT MEMORY EXPANSION CARD	EXIT

Select one of the following to perform the appropriate DIAGNOSTICS test:

- Select STATUS to determine the operational status of the Cash Dispenser.
- Select CLEAR DISPENSE ERROR to reset dispenser-related error indications.
- Select TEST DISPENSE to perform a combined dispense and reject operation on the dispensing mechanism.
- Select FORMAT MEMORY EXPANSION CARD to erase the contents of memory used to store Ad and printer graphics and prepare the memory to receive new data.
- Select the TEST RECEIPT PRINTER option to test the operation of the Receipt Printer.
- Select the VERSION #'S option to display a screen that provides version numbers for the various components of the terminal operating software.
- Select the MORE DIAGNOSTICS option to access the following diagnostic functions:
 - RESET/TEST MODEM. Select this option to verify that a modem is installed and that it is capable of being configured.
 - SCAN CARD. Select this option to verify that a customer's ATM or credit card can be read by the terminal card reader.

NOTE: The diagnostics options do not have a time-out associated with them. You must manually exit the diagnostics mode when you are finished.

ERROR CONDITIONS:

There are no error conditions directly associated with this function.

SECTION 5 - MANAGEMENT FUNCTIONS

FUNCTION: STATUS

FACTORY DEFAULT: N/A

ACCESS INSTRUCTIONS:

- 1.) Select **DIAGNOSTICS** from the **MANAGEMENT FUNCTIONS** screen.
- 2.) Select the **STATUS** option.

DESCRIPTION:

The **STATUS** command is used to check the operational condition of the various functional areas of the dispensing mechanism. Under normal circumstances, the Return Code should be “GQ”, which indicates that the mechanism is fully operational and ready to dispense. Any code other than “GQ” indicates a problem with the dispensing mechanism (such as a note jam), or a condition that should be checked (such as low note level).

The cancel button must be pressed to return to the diagnostics main menu.

ERROR CONDITIONS:

If any code other than “GQ” is indicated on the Return Code screen contact your service provider for assistance.



RETURN CODE: GQ

PRESS CANCEL TO CONTINUE

SECTION 5 - MANAGEMENT FUNCTIONS

FUNCTION: CLEAR DISPENSE ERROR

FACTORY DEFAULT: N/A

ACCESS INSTRUCTIONS:

- 1.) Select DIAGNOSTICS from the MANAGEMENT FUNCTIONS screen.
- 2.) Select the CLEAR DISPENSE ERROR option.

DESCRIPTION:

The CLEAR DISPENSE ERROR command instructs the dispenser to 'reset' all error indications except "BIN LOW" and STACKER BLOCKED" conditions (see Section 8, Error Conditions, for a description of dispenser error codes). If the underlying error conditions that caused the error indication(s) have been corrected, a Return Code value of 'GQ' should be displayed. Press the cancel key to return to the diagnostics main menu.

ERROR CONDITIONS:

If any code other than 'GQ' is displayed contact your service provider for assistance.



RETURN CODE: GQ

PRESS CANCEL TO CONTINUE

SECTION 5 - MANAGEMENT FUNCTIONS

FUNCTION: TEST DISPENSE

FACTORY DEFAULT: N/A

ACCESS INSTRUCTIONS:

- 1.) Select **DIAGNOSTICS** from the **MANAGEMENT FUNCTIONS** screen.
- 2.) Select the **TEST DISPENSE** option.

DESCRIPTION:

This command instructs the dispensing mechanism to dispense and reject one note from the note cassette. The note will be dispensed to the floor of the mechanism vault enclosure. This test exercises the dispenser without sending notes to the exterior note tray. A return code of 'GQ' indicates a successful test dispense. Press the cancel key to return to the diagnostics menu.

ERROR CONDITIONS:

If any code other than 'GQ' is displayed contact your service provider for assistance.

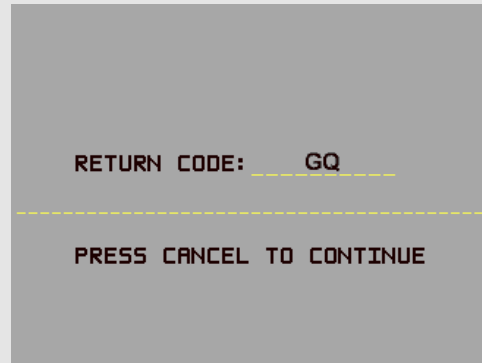

SECTION 5 - MANAGEMENT FUNCTIONS

FUNCTION: FORMAT MEMORY EXPANSION CARD

FACTORY DEFAULT: N/A

ACCESS INSTRUCTIONS:

- 1.) Select DIAGNOSTICS from the MANAGEMENT FUNCTIONS screen.
- 2.) Select the FORMAT MEMORY EXPANSION CARD option.

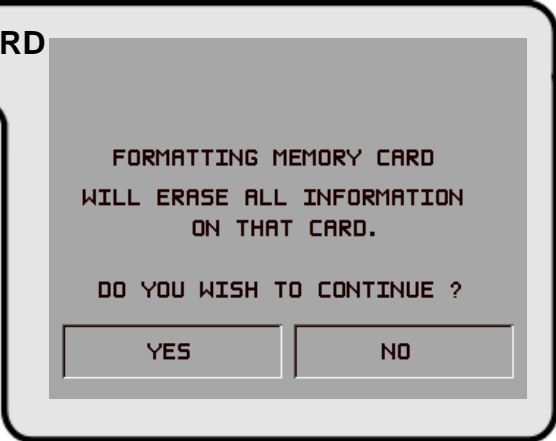

FORMATTING MEMORY CARD
WILL ERASE ALL INFORMATION
ON THAT CARD.

DO YOU WISH TO CONTINUE ?

YES

NO

DESCRIPTION:

Graphics Memory must be formatted so that it is ready to accept downloaded files from a Triton Connect Host Computer. Graphics Memory is factory formatted. If it becomes necessary to format Graphics Memory, the format operation can be accomplished from either the local terminal or through commands downloaded from a Triton Connect Host Computer.

****CAUTION****

Formatting Graphics Memory will erase all files currently stored in it. Do not format Graphics Memory unless you have the capability to download files to the terminal.

To format Graphics Memory, select YES at the continuation screen. The formatting process will begin and the following screen will be displayed:



ERROR CONDITIONS:

There are no error conditions directly associated with this function.

SECTION 5 - MANAGEMENT FUNCTIONS

FUNCTION: TEST RECEIPT PRINTER

FACTORY DEFAULT: N/A

ACCESS INSTRUCTIONS:

- 1.) Select DIAGNOSTICS from the MANAGEMENT FUNCTIONS screen.
- 2.) Select the TEST RECEIPT PRINTER option.

DESCRIPTION:

This command will print two lines of text on the receipt printer and then advance and cut the paper. The text should be 42 characters wide. The remainder of the information on the TEST RECEIPT PRINTER print out is terminal configuration data. If the printer test fails to print two lines of text, fails to advance the paper, or fails to cut the paper, contact your service provider for assistance. A return code of '00' indicates a successful printer test. Press the cancel key to return to the DIAGNOSTICS main menu.

ERROR CONDITIONS:

If any code other than '00' is displayed contact your service provider for assistance.

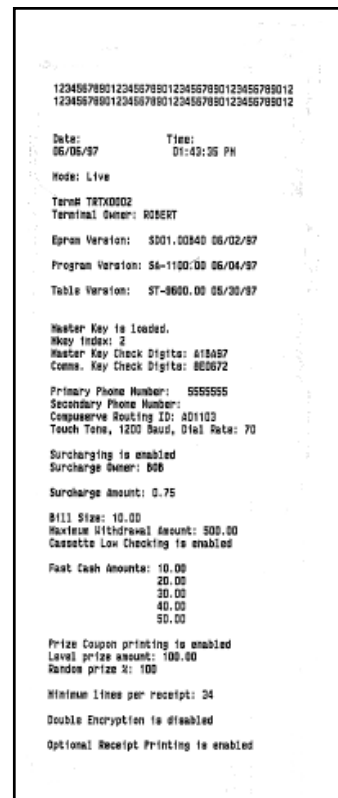
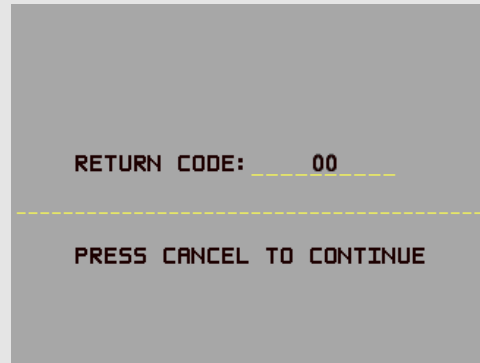

Sample RECEIPT PRINTER test results.

SECTION 5 - MANAGEMENT FUNCTIONS

FUNCTION: VERSION #'S

FACTORY DEFAULT: N/A

ACCESS INSTRUCTIONS:

- 1.) Select DIAGNOSTICS from the MANAGEMENT FUNCTIONS screen.
- 2.) Select the VERSION #'S option.

DESCRIPTION:

This function displays the version information for the terminal software that is running in the Cash Dispenser. Normally you do not need to access this function unless you are asked to by service personnel.

ERROR CONDITIONS:

There are no error conditions directly associated with this function.

PRESS ANY KEY TO CONTINUE

	Version	Date
EPROM	ND01.00	11/17/98
PROGRAM	NA-0002.00	12/21/98
TABLE	NT-0002.00	12/07/98
PARAM.	0002	12/08/98
LOAD	ND000002.00	12/21/98

SECTION 5 - MANAGEMENT FUNCTIONS

FUNCTION: MORE DIAGNOSTICS

FACTORY DEFAULT: N/A

ACCESS INSTRUCTIONS:

- 1.) Select DIAGNOSTICS from the MANAGEMENT FUNCTIONS screen.
- 2.) Select the MORE DIAGNOSTICS option.

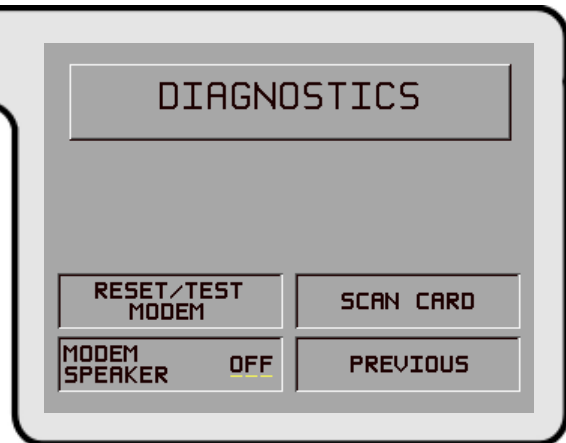

DESCRIPTION:

This screen allows you to select additional diagnostics functions. The functions available are:

- 1.) RESET/TEST MODEM, which performs a functional test of the modem hardware.
- 2.) MODEM SPEAKER ON/OFF, which enables you to turn the modem speaker audio on or off.
- 3.) SCAN CARD, which enables you to test a customer's ATM or credit card for proper operation in the terminal card reader.

ERROR CONDITIONS:

There are no error conditions directly associated with this function.

SECTION 5 - MANAGEMENT FUNCTIONS

FUNCTION: RESET/TEST MODEM

FACTORY DEFAULT: N/A

ACCESS INSTRUCTIONS:

- 1.) Select DIAGNOSTICS from the MANAGEMENT FUNCTIONS screen.
- 2.) Select MORE DIAGNOSTICS.
- 3.) Select the RESET/TEST MODEM option.



MODEM TESTING / INITIALIZATION
IN PROGRESS

PLEASE WAIT

DESCRIPTION:

This test confirms that the CPU Module can communicate with the modem and that the modem can be configured. This test does not test the ability of the modem to communicate on the phone line. If the RESET/TEST MODEM TEST fails, contact your service provider for assistance. Press the cancel key to return to the diagnostic's menu.

If the test is successful, the following message screen will be displayed:



MODEM CONFIGURED
AND
TESTED OK

PRESS CANCEL TO CONTINUE

ERROR CONDITIONS:

If the test fails, an error message will be displayed.

SECTION 5 - MANAGEMENT FUNCTIONS

FUNCTION: MODEM SPEAKER ON/OFF

FACTORY DEFAULT: OFF

ACCESS INSTRUCTIONS:

- 1.) Select DIAGNOSTICS from the MANAGEMENT FUNCTIONS screen.
- 2.) Select MORE DIAGNOSTICS.

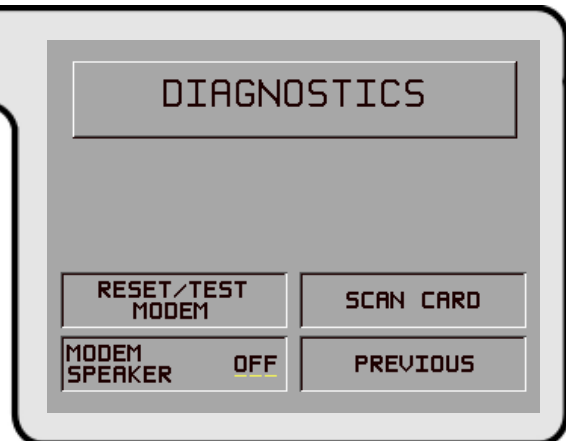

DESCRIPTION:

This function allows you to turn the modem speaker sound on or off. The modem speaker output could be turned on, for example, during troubleshooting of communications problems, to verify the modem is actually accessing the telephone line.

The current state of the modem speaker is shown as either ON or OFF in the button label on the display. Press the keypad button next to the label to toggle the state of the modem speaker between ON and OFF.

ERROR CONDITIONS:

There are no error conditions directly associated with this function.

SECTION 5 - MANAGEMENT FUNCTIONS

FUNCTION: SCAN CARD

FACTORY DEFAULT: N/A

ACCESS INSTRUCTIONS:

- 1.) Select DIAGNOSTICS from the MANAGEMENT FUNCTIONS screen.
- 2.) Select MORE DIAGNOSTICS.
- 3.) Select the SCAN CARD option.



PLEASE **INSERT** AND THEN REMOVE
THE CARD TO BE SCANNED

EXIT

DESCRIPTION:

The SCAN CARD function reads a card and displays the information imprinted on its magnetic strip. This can be done on a customer card that doesn't seem to work in the Cash Dispenser. If the customer complains of card read errors, first make sure that he or she is inserting the card correctly. Then try to read the card with SCAN CARD. If the card can be read properly, the information from track 1 and track 2 will be displayed. A card need only have a readable track 2 to operate successfully in the Cash Dispenser.

A series of prompt screens direct the user to first **INSERT** the card to be scanned (shown above) and then to **REMOVE** it, after which the results of the scan are presented, as shown in the following:

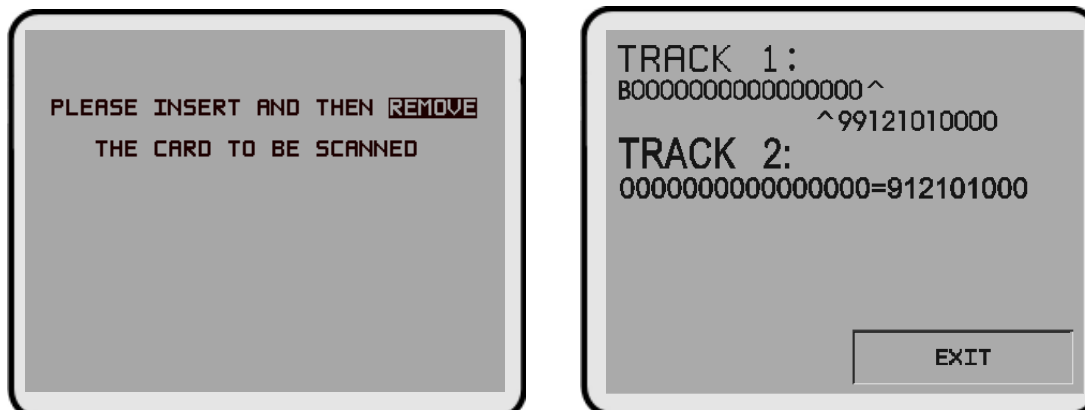

ERROR CONDITIONS:

If the card is damaged or not a standard format, the screen will display an error message. If this happens, the card cannot be used for transactions on the Cash Dispenser.

SECTION 5 - MANAGEMENT FUNCTIONS

FUNCTION: LANGUAGE/IDIOMA

FACTORY DEFAULT: Country-specific

ACCESS INSTRUCTIONS:

Select the LANGUAGE/IDIOMA option from the MANAGEMENT FUNCTIONS screen to view the additional options available.

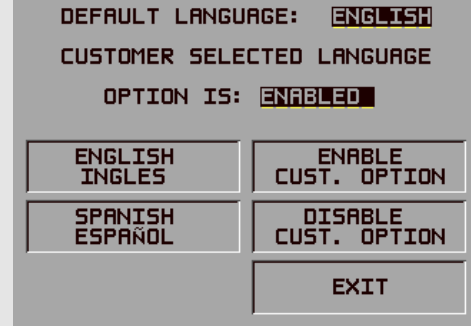

DESCRIPTION:

This function provides access to the options that control the language that is displayed on the Cash Dispenser LCD Display. Current language options include English or Spanish (certain international versions of terminal software provide a French option instead of Spanish), and a customer option feature enables or disables customer-selection of the language in which text is presented on the LCD display.

- 1.) ENGLISH / INGLES
- 2.) SPANISH / ESPAÑOL
- 3.) ENABLE CUST. OPTION
- 4.) DISABLE CUST. OPTION

ERROR CONDITIONS:

There are no error conditions directly associated with this function.

SECTION 5 - MANAGEMENT FUNCTIONS

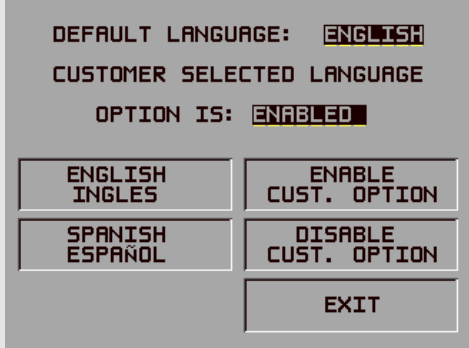
<p>FUNCTION: ENGLISH/INGLES</p> <p>FACTORY DEFAULT: N/A</p> <p>ACCESS INSTRUCTIONS:</p> <ol style="list-style-type: none"> 1.) Select the LANGUAGE/IDIOMA option from the MANAGEMENT FUNCTIONS screen. 2.) Select the ENGLISH/INGLES option. <p>DESCRIPTION:</p> <p>Choosing this function when the DISABLE CUST. OPTION is selected will set the LCD screen to display only English text during a transaction.</p> <p>Choosing this function when the ENABLE CUST. OPTION is selected will present customer transaction text in English initially, but will allow the customer to choose English or Spanish (or French for some versions of terminal software).</p> <p>In addition to the customer transactions taking place in the English language, all Management Functions will be presented in English. All receipts will be printed in English text, as well.</p> <p>ERROR CONDITIONS:</p> <p>There are no error conditions directly associated with this function.</p>	
--	--

SECTION 5 - MANAGEMENT FUNCTIONS

FUNCTION: SPANISH/ESPANOL

FACTORY DEFAULT: N/A

ACCESS INSTRUCTIONS:

- 1.) Select the LANGUAGE/IDIOMA option from the MANAGEMENT FUNCTIONS screen.
- 2.) Select the SPANISH/ESPANOL option.



DESCRIPTION:

NOTE: Some versions of international software replace the Spanish language option with French.

Choosing this option when the DISABLE CUST. OPTION is selected will display only Spanish text during a transaction.

Choosing this option when the ENABLE CUST. OPTION is selected will give the customer the option of completing the transaction in either English or Spanish.

In addition to the transaction taking place in the Spanish language, all Management Functions will be presented in Spanish.

Some terminal software versions support the printing of receipts in Spanish.

ERROR CONDITIONS:

There are no error conditions directly associated with this function.

SECTION 5 - MANAGEMENT FUNCTIONS

FUNCTION: ENABLE/DISABLE CUST. OPTION

FACTORY DEFAULT: 'OPTION IS: DISABLED'

ACCESS INSTRUCTIONS:

- 1.) Select the LANGUAGE/IDIOMA option from the MANAGEMENT FUNCTIONS screen.
- 2.) Select either option, as appropriate:
 - ENABLE CUST. OPTION.
 - DISABLE CUST. OPTION.



DESCRIPTION:

If the mode is ENABLED, the customer will be offered a bilingual screen instructing them to select a desired language (currently English and either Spanish or French depending upon software version) for the transaction. If the mode is DISABLED, the customer will not be offered this option.

ERROR CONDITIONS:

There are no error conditions directly associated with this function.

SECTION 5 - MANAGEMENT FUNCTIONS

FUNCTION: JOURNAL

FACTORY DEFAULT: N/A

ACCESS INSTRUCTIONS:

Select JOURNAL from the options available at the MANAGEMENT FUNCTIONS screen.

DESCRIPTION:

Select the JOURNAL function from the MANAGEMENT FUNCTIONS screen to:

- 1.) PRINT THE JOURNAL
- 2.) CLEAR JOURNAL
- 3.) PRINT THE LAST X ENTRIES

ERROR CONDITIONS:

There are no error conditions directly associated with this function.

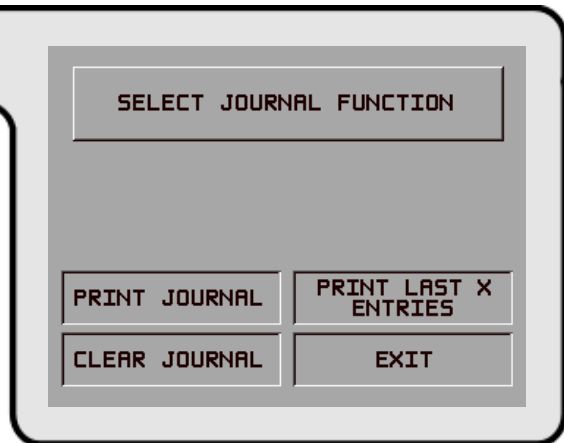

SECTION 5 - MANAGEMENT FUNCTIONS

FUNCTION: PRINT JOURNAL

FACTORY DEFAULT: N/A

ACCESS INSTRUCTIONS:

- 1.) Select JOURNAL from the options available at the MANAGEMENT FUNCTIONS screen.
- 2.) Select the PRINT JOURNAL option to print all unaudited records stored in the Electronic Journal.

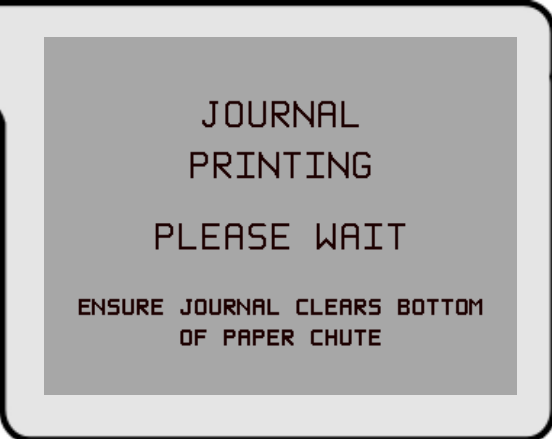

JOURNAL
PRINTING
PLEASE WAIT
ENSURE JOURNAL CLEARS BOTTOM
OF PAPER CHUTE

DESCRIPTION:

The PRINT JOURNAL command is used to automatically print out any journal entries collected since the last time the journal was printed. ALL journal records will be printed, whether there are 1 or 2045 records. This command should be used regularly to print the audit trail of the terminal. This information should be maintained in case of an inquiry by a customer, and can also be useful in certain troubleshooting situations.

When this command is run, all unaudited records in the Electronic Journal are immediately sent to the receipt printer, and subsequently marked as audited. Any record printed in this fashion will not be printed again by this command, although it can be printed using the PRINT LAST X ENTRIES command. When the journal has finished printing, the SELECT JOURNAL FUNCTION screen will be displayed.

ERROR CONDITIONS:

If the operation fails, an error message will be displayed.

SECTION 5 - MANAGEMENT FUNCTIONS

FUNCTION: CLEAR JOURNAL

FACTORY DEFAULT: N/A

ACCESS INSTRUCTIONS:

- 1.) Select JOURNAL from the options available at the MANAGEMENT FUNCTIONS screen.
- 2.) Select the CLEAR JOURNAL option to mark all journal entries stored in the Electronic Journal since the last time the CLEAR JOURNAL or PRINT JOURNAL functions were completed.

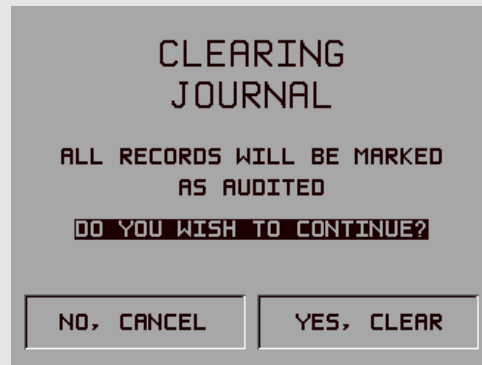

DESCRIPTION:

The CLEAR JOURNAL command is used to mark all unprinted records in the journal as 'audited'. This means that they will not be printed out the next time a PRINT JOURNAL command is performed. Audited records are not erased. They are marked as if they had been printed. When this function is selected, a confirmation screen prompts the user to answer YES, CLEAR to continue with operation or NO, CANCEL to quit. If the user answers YES, CLEAR, the following screen will be displayed:

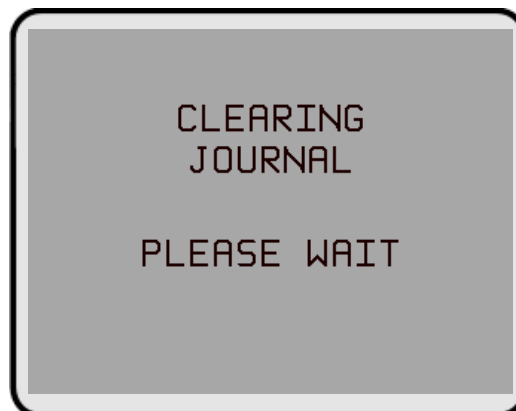

When the journal has been cleared, the SELECT JOURNAL FUNCTION screen will be displayed. Note that even after this command has been completed, records are still available for printing by using the PRINT LAST X ENTRIES command.

ERROR CONDITIONS:

If the operation fails, an error message will be displayed.

SECTION 5 - MANAGEMENT FUNCTIONS

FUNCTION: PRINT LAST X ENTRIES

FACTORY DEFAULT: N/A

ACCESS INSTRUCTIONS:

- 1.) Select JOURNAL from the options available at the MANAGEMENT FUNCTIONS screen.
- 2.) Select the PRINT LAST X ENTRIES option to print the last X (where 'X' is a number from 1 to 2045) entries stored in the Electronic Journal.

ENTER THE NUMBER OF RECORDS

TO PRINT

AND THEN PRESS 'OK'

DESCRIPTION:

This command is used to reprint records from the Electronic Journal, either before or after they have been audited using the CLEAR JOURNAL or PRINT JOURNAL commands. Records printed out using this command are not marked in any way. This command will not affect the operation of the PRINT JOURNAL command.

This command is used for several purposes. It can be used to reprint records for which the paper trail has been lost or destroyed. It can also be used to print out records before they are audited, for diagnostic purposes.

When using this command, the user is prompted to enter the number of the most recently collected records to be printed. It always operates on the last 'X' entries. If an operator needs to see a transaction that happened about 10 records earlier, entering '13' at the prompt will cause the last 13 records to be printed, but not cleared, from the buffer. This will ensure that the transaction in question is printed.

Subsequent uses of this command are not cumulative. No pointer is maintained that 'moves' each time this command is run. It always operates on the LAST X ENTRIES.

ERROR CONDITIONS:

Entering a number greater than the number of records in the buffer memory of the journal will cause all records to be printed. The buffer memory can contain up to 2045 records at any one time.

SECTION 5 - MANAGEMENT FUNCTIONS

FUNCTION: PASSWORD MAINTENANCE

FACTORY DEFAULT: N/A

ACCESS INSTRUCTIONS:

Select the PASSWORD MAINTENANCE option from the MANAGEMENT FUNCTIONS screen.

DESCRIPTION:

The PASSWORD MAINTENANCE Function of MANAGEMENT FUNCTIONS menu allows access to menus for viewing and changing the following:

- 1.) MASTER PASSWORD
- 2.) ADMINISTRATION PASSWORD

ERROR CONDITIONS:

There are no error conditions directly associated with this function.

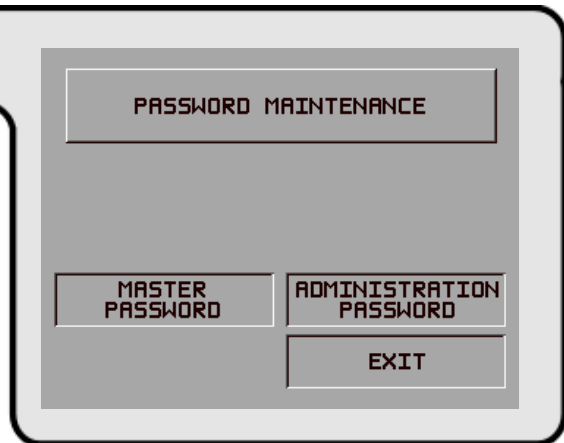

SECTION 5 - MANAGEMENT FUNCTIONS

FUNCTION: MASTER PASSWORD

FACTORY DEFAULT: '123456'

ACCESS INSTRUCTIONS:

- 1.) Select the PASSWORD MAINTENANCE option from the MANAGEMENT FUNCTIONS screen.
- 2.) Select the MASTER PASSWORD option.

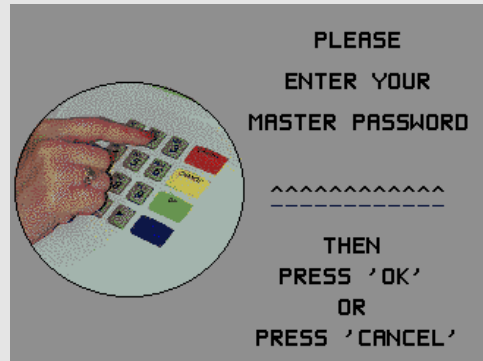

DESCRIPTION:

The MASTER PASSWORD is the highest level password on the Cash Dispenser. It allows access to all functions except downloading of new software. The MASTER PASSWORD must be entered in order to change the ADMINISTRATION password. The factory default MASTER PASSWORD is '123456' and should be changed when the Cash Dispenser is installed.

To change the MASTER PASSWORD, select this function. You will be prompted to enter your new password. An asterisk (*) will be displayed in place of the actual digits entered; therefore, you must enter the password a second time when prompted to confirm it.

The password can be from 4 to 12 digits long and can contain only numbers; letters are not allowed.

ERROR CONDITIONS:

A number of feedback screens may appear during password entry. These screens can appear if the second password entry did not match the first, you entered an invalid password, or the password you entered was too short (less than 4 characters).

SECTION 5 - MANAGEMENT FUNCTIONS

FUNCTION: ADMINISTRATION PASSWORD

FACTORY DEFAULT: '987654'

ACCESS INSTRUCTIONS:

- 1.) Select the PASSWORD MAINTENANCE option from the MANAGEMENT FUNCTIONS screen.
- 2.) Select the ADMINISTRATION PASSWORD option.

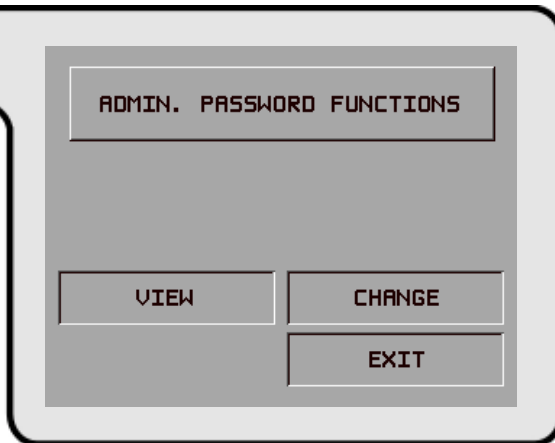

DESCRIPTION:

The ADMINISTRATION PASSWORD is used to perform daily management functions. This password DOES NOT allow access to the TERMINAL CONFIGURATION menu.

This password can only be changed when the MASTER PASSWORD is used to enter the MANAGEMENT FUNCTIONS area. Use the options provided to VIEW or CHANGE the password, as shown in the figures below. When the VIEW option is selected, the current password will be displayed for a few seconds. When changing the password, it must be entered twice, because the characters entered are not displayed (an asterisk (*) is displayed in place of each character, for security reasons). The password length can range from 4 to 12 characters.



VIEW

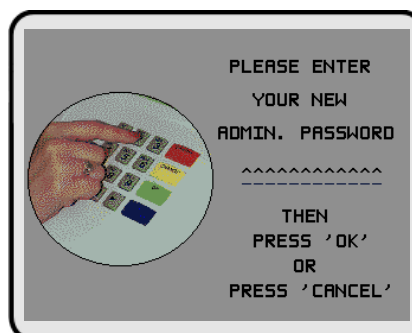

CHANGE

ERROR CONDITIONS:

A number of feedback screens may appear during password entry. These screens can appear if the second password entry did not match the first, you entered an invalid password, or the password you entered was too short (less than 4 characters).

SECTION 5 - MANAGEMENT FUNCTIONS

FUNCTION: TERMINAL CONFIGURATION

FACTORY DEFAULT: N/A

ACCESS INSTRUCTIONS:

Select the **TERMINAL CONFIGURATION** option from the **MANAGEMENT FUNCTIONS** screen.

DESCRIPTION:

The **TERMINAL CONFIGURATION** option provides access to functions that allow the following parameters to be viewed and changed:

- 1.) **PRINTER SETTINGS**
- 2.) **RANDOM/LEVEL PRIZE COUPONS**
- 3.) **CHANGE MESSAGES**
- 4.) **SET TERMINAL PARAMETERS**
- 5.) **DATE / TIME FUNCTIONS**
- 6.) **TRANSACTION TYPES**
- 7.) **ACCOUNT TYPES**

ERROR CONDITIONS:

There are no error conditions directly associated with this function.

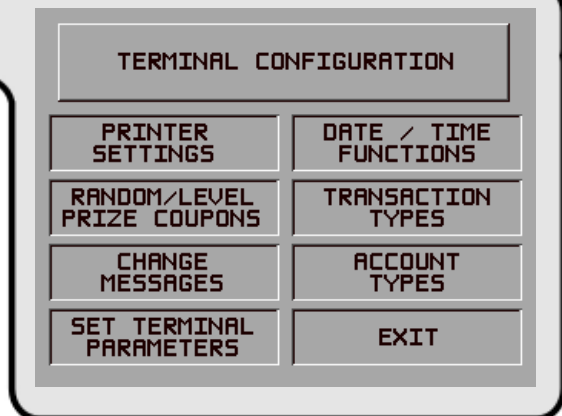

SECTION 5 - MANAGEMENT FUNCTIONS

FUNCTION: PRINTER SETTINGS

FACTORY DEFAULT: N/A

ACCESS INSTRUCTIONS:

- 1.) Select the **TERMINAL CONFIGURATION** option from the **MANAGEMENT FUNCTIONS** screen.
- 2.) Select the **PRINTER SETTINGS** option.

DESCRIPTION:

This menu provides access to the following functions:

- 1.) **SET PRINT LENGTH**
- 2.) **LOW RECEIPT PAPER**
- 3.) **PRINTER GRAPHICS**

ERROR CONDITIONS:

There are no error conditions directly associated with this function.

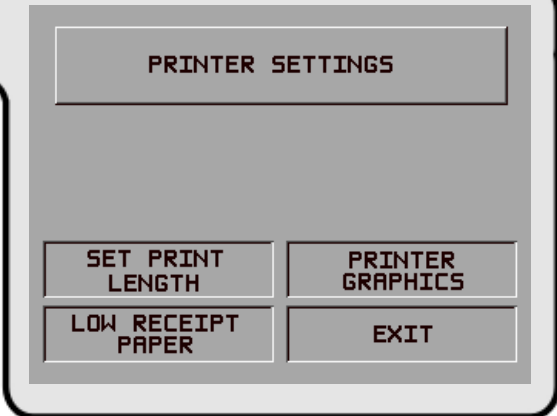

The screenshot shows a touch-screen interface for the 'PRINTER SETTINGS' menu. At the top is a header box labeled 'PRINTER SETTINGS'. Below it is a large empty rectangular area. At the bottom, there are four rectangular buttons arranged in a 2x2 grid. The top-left button is labeled 'SET PRINT LENGTH', the top-right is 'PRINTER GRAPHICS', the bottom-left is 'LOW RECEIPT PAPER', and the bottom-right is 'EXIT'.

SECTION 5 - MANAGEMENT FUNCTIONS

FUNCTION: SET PRINT LENGTH

FACTORY DEFAULT: '35'

ACCESS INSTRUCTIONS:

- 1.) Select the **TERMINAL CONFIGURATION** option from the **MANAGEMENT FUNCTIONS** screen.
- 2.) Select the **PRINTER SETTINGS** option.
- 3.) Select **SET PRINT LENGTH**.

MINIMUM PRINT LENGTH: ___
(NUMBER OF LINES PER RECEIPT)

ENTER MIN. # LINES (0-99)

CHANGE

EXIT

DESCRIPTION:

This function sets the minimum length of the receipt provided to the customer after each transaction.

ERROR CONDITIONS:

Changing the Print Length to less than 35 lines will prevent the receipt from exiting the front of the Cash Dispenser. This may cause paper jams that could result in printer damage.

SECTION 5 - MANAGEMENT FUNCTIONS

FUNCTION: LOW RECEIPT PAPER

FACTORY DEFAULT: 'OUT OF SERVICE'

ACCESS INSTRUCTIONS:

- 1.) Select **TERMINAL CONFIGURATION** from the **MANAGEMENT FUNCTIONS** menu.
- 2.) Select the **PRINTER SETTINGS** option.
- 3.) Choose the **LOW RECEIPT PAPER** option.

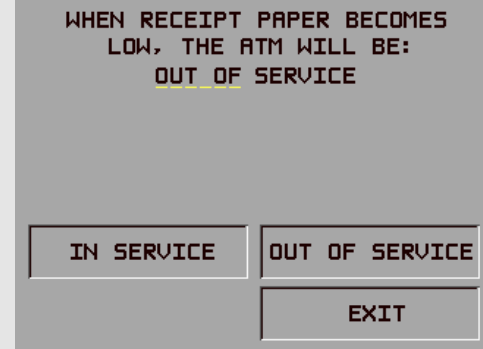

DESCRIPTION:

After selecting the **LOW RECEIPT PAPER ON/OFF** option, a screen displaying, "WHEN RECEIPT PAPER BECOMES LOW, THE ATM WILL BE OUT OF SERVICE" (or **IN SERVICE** depending on terminal setup). Change to **IN SERVICE** or **OUT OF SERVICE** by pressing the Screen Key next to the appropriate text and pressing the **EXIT** key.

Selecting the **IN SERVICE** options will allow the terminal to continue to operate after it senses a Receipt Printer Paper Low condition (Error Code 183). *Selecting this option will allow the terminal to operate with low or no receipt paper in the terminal.*

Selecting the **OUT OF SERVICE** option will allow the terminal to report a Receipt Printer Paper Low condition (Error Code 183), and will place the terminal in an **OUT OF SERVICE** condition until the receipt paper is replenished.

ERROR CONDITIONS:

Error Code 183 – Receipt Printer Paper Low will take the terminal **OUT OF SERVICE**. To restore the terminal to normal operation the paper must be replenished and the Reset Error button pressed after the terminal has been reset and is displaying the **OUT OF SERVICE** screen.

SECTION 5 - MANAGEMENT FUNCTIONS

FUNCTION: PRINTER GRAPHICS

FACTORY DEFAULT: ENABLED

ACCESS INSTRUCTIONS:

- 1.) Select **TERMINAL CONFIGURATION** option from the **MANAGEMENT FUNCTIONS** screen.
- 2.) Select the **PRINTER SETTINGS** option.
- 3.) Select **PRINTER GRAPHICS**.

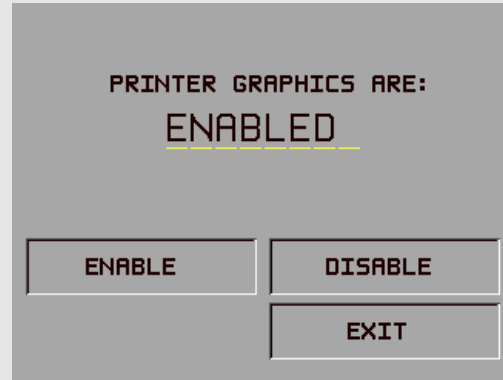

DESCRIPTION:

The Printed Graphics feature can only be used when an optional Memory Expansion Card is installed in the terminal. Triton Connect Software Release 1.8 (or above) allows bit mapped graphics (in '.bmp' format) to be downloaded to the terminal. This graphic will be printed on the receipt when the **PRINTER GRAPHICS** option has been **ENABLED**. This feature cannot be supported without the addition of an Expansion Memory Card.

To turn on the **PRINTER GRAPHICS** feature, choose the **ENABLE** option on this screen. To inhibit the **PRINTER GRAPHICS** feature, press the **DISABLE** key.

ERROR CONDITIONS:

If **PRINTER GRAPHICS** is enabled and there are no graphic images loaded into the Expansion Memory Card, the receipt printer will print normal receipts without graphics. There are no error conditions associated with this function.

SECTION 5 - MANAGEMENT FUNCTIONS

FUNCTION: RANDOM/LEVEL PRIZE COUPONS

FACTORY DEFAULT: N/A

ACCESS INSTRUCTIONS:

- 1.) Select **TERMINAL CONFIGURATION** from the **MANAGEMENT FUNCTIONS** menu.
- 2.) Select **RANDOM/LEVEL PRIZE COUPONS** from the **TERMINAL CONFIGURATION** menu.

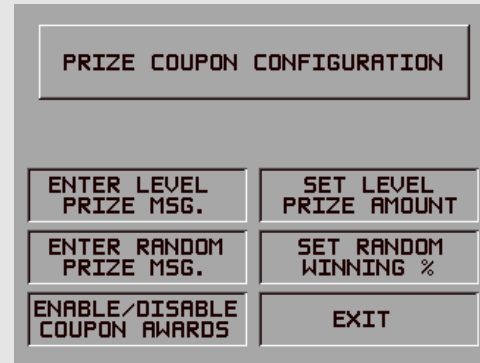

DESCRIPTION:

This function provides access to the following options, which will set up terminal operations for issuing printed and dispensed prize coupons:

- 1.) ENTER LEVEL/PRIZE MESSAGE.
- 2.) ENTER RANDOM PRIZE MESSAGE.
- 3.) ENABLE/DISABLE COUPON AWARDS.
- 4.) SET LEVEL PRIZE AMOUNT.
- 5.) SET RANDOM WINNING %.

ERROR CONDITIONS:

There are no error conditions directly associated with this function.

SECTION 5 - MANAGEMENT FUNCTIONS

FUNCTION: ENTER LEVEL PRIZE MSG.

FACTORY DEFAULT: NONE

ACCESS INSTRUCTIONS:

- 1.) Select TERMINAL CONFIGURATION from the MANAGEMENT FUNCTIONS menu.
- 2.) Select RANDOM/LEVEL PRIZE COUPONS from the TERMINAL CONFIGURATION menu.
- 3.) Select ENTER LEVEL PRIZE MSG.

F1 CENTER LINE LEFT F6
 F2 CLEAR ALL CENTER F7
 F3 CLEAR LINE RIGHT F8
 F4 CASE UPPER

DESCRIPTION:

The LEVEL PRIZE MESSAGE consists of four lines of text that are printed on the Level Prize receipt and report. The text can be full alphanumeric text. Enter letters, numbers and punctuation as follows:

The keys along either side of the display are used with the numeric keys on the main keypad to permit entry of alphanumeric characters. The keys on the left side of the display are designated <F6> through <F8>. The keys on the right side of the display are <F6> through <F8>. The <F1> key centers the text on the line where the cursor appears. The <F2> key erases all text in the current message. <F3> clears the text on the line the cursor is currently appearing.

KEY	1	2	3	4	5	6	7	8	9	0
F4 UPPER
No Shift	1	2	3	4	5	6	7	8	9	0
F6 Left	Q	A	D	G	J	M	P	T	W	,
F7 Center	Z	B	E	H	K	N	R	U	X	.
F8 Right	Sp	C	F	I	L	O	S	V	Y	-
F4 LOWER										
No Shift	!	@	#	\$	%	^	&	*	()
F6 Left	q	a	d	g	j	m	p	t	w	'
F7 Center	z	b	c	h	k	n	r	u	x	+
F8 Right	&	c	f	i	l	o	s	v	y	=

The <F4> Key is used similarly to a CAPS LOCK key on a computer keyboard. Pressing the <F4> key toggles between uppercase and lowercase. To enter an alphabetic or punctuation character, one of the <F6> through <F8> keys must be pressed, followed by one of the numeric keys. The resultant character will be as indicated in the table. Press the <OK> key to save the changes made. If you make a mistake and want to start over, press the CANCEL key to discard any changes made to that point.

ERROR CONDITIONS:

There are no error conditions directly associated with this function.

SECTION 5 - MANAGEMENT FUNCTIONS

FUNCTION: ENTER RANDOM PRIZE MSG.

FACTORY DEFAULT: NONE

ACCESS INSTRUCTIONS:

- 1.) Select TERMINAL CONFIGURATION from the MANAGEMENT FUNCTIONS menu.
- 2.) Select RANDOM/LEVEL PRIZE COUPONS from the TERMINAL CONFIGURATION menu.
- 3.) Select ENTER RANDOM PRIZE MSG.

F1 CENTER LINE LEFT F6
 F2 CLEAR ALL CENTER F7
 F3 CLEAR LINE RIGHT F8
 F4 CASE UPPER

DESCRIPTION:

The RANDOM PRIZE MESSAGE consists of four lines of text that are printed on the Random Coupon receipt and report. The text can be full alphanumeric text. Enter desired letters, numbers and punctuation as follows:

KEY	1	2	3	4	5	6	7	8	9	0
F4 UPPER
No Shift	1	2	3	4	5	6	7	8	9	0
F6 Left	Q	A	D	G	J	M	P	T	W	,
F7 Center	Z	B	E	H	K	N	R	U	X	.
F8 Right	Sp	C	F	I	L	O	S	V	Y	-
F4 LOWER										
No Shift	!	@	#	\$	%	^	&	*	()
F6 Left	q	a	d	g	j	m	p	t	w	'
F7 Center	z	b	c	h	k	n	r	u	x	+
F8 Right	&	c	f	i	l	o	s	v	y	=

The keys along either side of the display are used with the numeric keys on the main keypad to permit entry of alphanumeric characters. The keys on the left side of the display are designated <F1> through <F4>. The keys on the right side of the display are <F6> through <F8>. The <F1> key centers the text on the line where the cursor appears. The <F2> key erases all text in the current message. <F3> clears the text on the line the cursor is currently appearing.

The <F4> Key is used similarly to a CAPS LOCK key on a computer keyboard. Pressing the <F4> key toggles between uppercase and lowercase. To enter an alphabetic or punctuation character, one of the <F6> through <F8> keys must be pressed, followed by one of the numeric keys. The resultant character will be as indicated in the table. Press the <OK> key to save the changes made. If you make a mistake and want to start over, press the CANCEL key to discard any changes made to that point.

ERROR CONDITIONS:

There are no error conditions directly associated with this function.

SECTION 5 - MANAGEMENT FUNCTIONS

FUNCTION: ENABLE/DISABLE COUPON AWARDS

FACTORY DEFAULT: DISABLED

ACCESS INSTRUCTIONS:

- 1.) Select **TERMINAL CONFIGURATION** from the **MANAGEMENT FUNCTIONS** menu.
- 2.) Select **RANDOM/LEVEL PRIZE COUPONS** from the **TERMINAL CONFIGURATION** menu.
- 3.) Select the **ENABLE/DISABLE COUPON AWARDS** option.
- 4.) Select **ENABLE OR DISABLE** from the menu displayed.

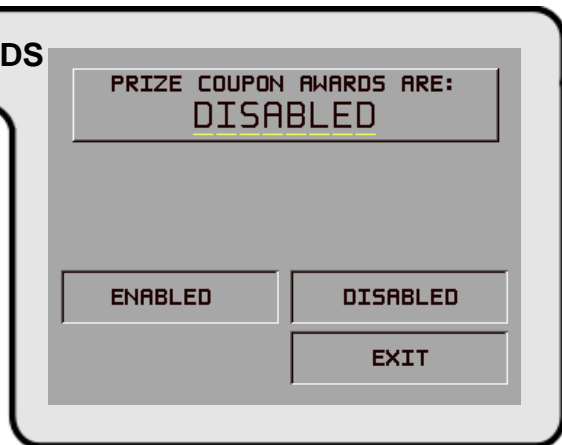

DESCRIPTION:

This function provides access to a menu that allows the operator to **ENABLE** or **DISABLE** all printed coupon awards. If **ENABLED**, eligible transactions will be checked for award. If **DISABLED**, no coupons will be issued.

ERROR CONDITIONS:

There are no error conditions directly associated with this function.

SECTION 5 - MANAGEMENT FUNCTIONS

FUNCTION: SET LEVEL PRIZE AMOUNT

FACTORY DEFAULT: '\$0.00'

ACCESS INSTRUCTIONS:

- 1.) Select **TERMINAL CONFIGURATION** from the **MANAGEMENT FUNCTIONS** menu.
- 2.) Select **RANDOM/LEVEL PRIZE COUPONS** from the **TERMINAL CONFIGURATION** menu.
- 3.) Select the **SET LEVEL PRIZE AMOUNT** option.
- 4.) Enter the amount in dollars and press "<OK>".

The screenshot shows a terminal screen with the following text and elements:

- Header: LEVEL PRIZE COUPON THRESHOLD
- Value: \$.00 (with a dashed line under the decimal point)
- Instruction: ENTER NEW LEVEL, THEN PRESS OK
- Buttons: CHANGE and EXIT

DESCRIPTION:

This function sets the threshold level at which the level prize coupon will be printed. Withdrawing an amount equal to or greater than the value set here will print the level prize coupon.

NOTE: If the level coupon is awarded, the random coupon parameter will not be tested for award.

ERROR CONDITIONS:

There are no error conditions directly associated with this function.

SECTION 5 - MANAGEMENT FUNCTIONS

FUNCTION: SET RANDOM WINNING %

FACTORY DEFAULT: '0%'

ACCESS INSTRUCTIONS:

- 1.) Select TERMINAL CONFIGURATION from the MANAGEMENT FUNCTIONS menu.
- 2.) Select RANDOM/LEVEL PRIZE COUPONS from the TERMINAL CONFIGURATION menu.
- 3.) Select the SET RANDOM WINNING % option.
- 4.) Select the CHANGE option.
- 5.) Enter the new random percentage and press <OK>.

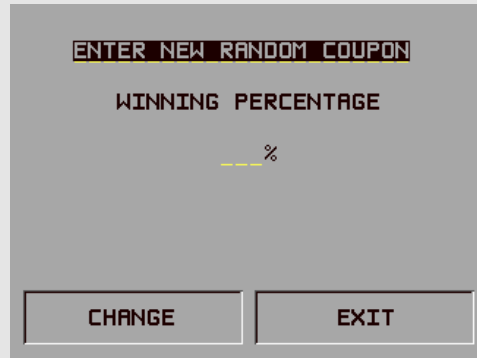

DESCRIPTION:

This function sets the frequency at which the random prize coupons will be printed. The random coupon is won by a random number of transactions of any type. The winning percentage can be set from 0 to 100%. For example, if the winning percentage is set to 10%, then 1 out of every 10 transactions will be awarded a prize.

ERROR CONDITIONS:

There are no error conditions directly associated with this function.

SECTION 5 - MANAGEMENT FUNCTIONS

FUNCTION: CHANGE MESSAGES

FACTORY DEFAULT: N/A

ACCESS INSTRUCTIONS:

- 1.) Select **TERMINAL CONFIGURATION** from the **MANAGEMENT FUNCTIONS** menu.
- 2.) Select **CHANGE MESSAGES**.

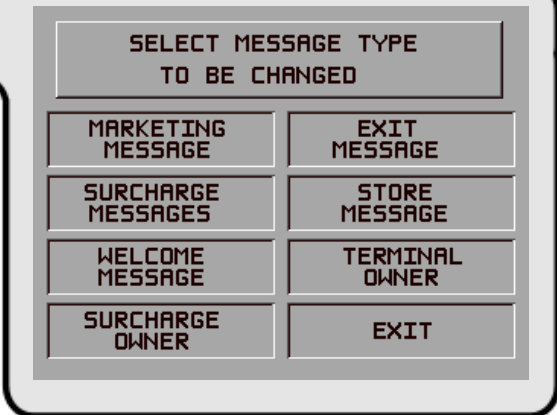

SELECT MESSAGE TYPE TO BE CHANGED	
MARKETING MESSAGE	EXIT MESSAGE
SURCHARGE MESSAGES	STORE MESSAGE
WELCOME MESSAGE	TERMINAL OWNER
SURCHARGE OWNER	EXIT

DESCRIPTION:

The **CHANGE MESSAGES** option of the **TERMINAL CONFIGURATION** menu allows information for the following screens to be changed by the terminal operator or a service technician:

- 1.) **MARKETING MESSAGE**
- 2.) **SURCHARGE MESSAGES**
- 3.) **WELCOME MESSAGE**
- 4.) **SURCHARGE OWNER**
- 5.) **EXIT MESSAGE**
- 6.) **STORE MESSAGE**
- 7.) **TERMINAL OWNER**

NOTE: In some versions of the terminal operating software the Marketing Message may appear on the right side of the display.

ERROR CONDITIONS:

There are no error conditions directly associated with this function

SECTION 5 - MANAGEMENT FUNCTIONS

FUNCTION: MARKETING MESSAGE

FACTORY DEFAULT: NONE

ACCESS INSTRUCTIONS:

- 1.) Select **TERMINAL CONFIGURATION** from the **MANAGEMENT FUNCTIONS** menu.
- 2.) Select **CHANGE MESSAGES**.
- 3.) Select **MARKETING MESSAGE**.

F1 CENTER LINE
 F2 CLEAR ALL
 F3 CLEAR LINE
 F4 CASE UPPER

LEFT F6
 CENTER F7
 RIGHT F8

DESCRIPTION:

The **MARKETING MESSAGE** function allows you to compose a message that will appear on any printed products that include the store message (e.g. customer receipts, day closes, coupons, etc.). The message can be up to four lines long. Enter letters, numbers and punctuation as follows:

KEY	1	2	3	4	5	6	7	8	9	0
F4 UPPER
No Shift	1	2	3	4	5	6	7	8	9	0
F6 Left	Q	A	D	G	J	M	P	T	W	,
F7 Center	Z	B	E	H	K	N	R	U	X	.
F8 Right	Sp	C	F	I	L	O	S	V	Y	-
F4 LOWER										
No Shift	!	@	#	\$	%	^	&	*	()
F6 Left	q	a	d	g	j	m	p	t	w	'
F7 Center	z	b	c	h	k	n	r	u	x	+
F8 Right	&	c	f	i	l	o	s	v	y	=

The keys along either side of the display are used with the numeric keys on the main keypad to permit entry of alphanumeric characters. The keys on the left side of the display are designated <F1> through <F4>. The keys on the right side of the display are <F6> through <F8>. The <F1> key centers the text on the line where the cursor appears. The <F2> key erases all text in the current message. <F3> clears the text on the line the cursor is currently appearing.

The <F4> Key is used similarly to a CAPS LOCK key on a computer keyboard. Pressing the <F4> key toggles between uppercase and lowercase. To enter an alphabetic or punctuation character, one of the <F6> through <F8> keys must be pressed, followed by one of the numeric keys. The resultant character will be as indicated in the table. Press the <OK> key to save the changes made. If you make a mistake and want to start over, press the CANCEL key to discard any changes made to that point.

ERROR CONDITIONS:

There are no error conditions directly associated with this function.

SECTION 5 - MANAGEMENT FUNCTIONS

FUNCTION: SURCHARGE MESSAGES

FACTORY DEFAULT: 'CUSTOM-D'

ACCESS INSTRUCTIONS:

- 1.) Select TERMINAL CONFIGURATION from the MANAGEMENT FUNCTIONS menu.
- 2.) Select CHANGE MESSAGES.
- 3.) Select SURCHARGE MESSAGES

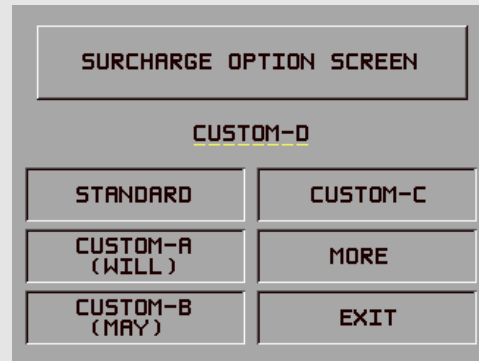

DESCRIPTION:

This function is used to select the surcharge message that will be displayed to the customer. Press the button next to the desired message to select it. Message options STANDARD, A, B and C are accessed from the first SURCHARGE OPTION SCREEN. The MORE option leads to a second screen containing message options D, E, F, G, and H. Choose the message allowed by the applicable state and network regulations.

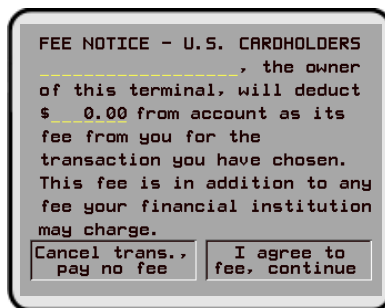

STANDARD

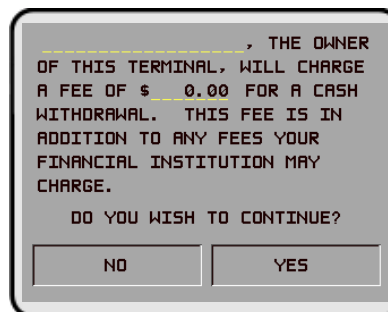

CUSTOM-A

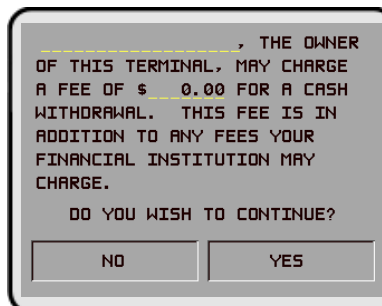

CUSTOM-B

SECTION 5 - MANAGEMENT FUNCTIONS

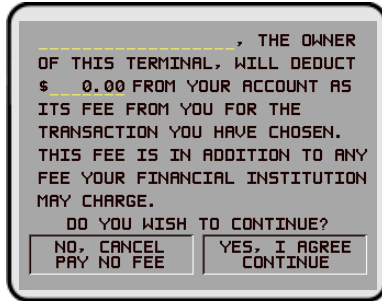

CUSTOM-C

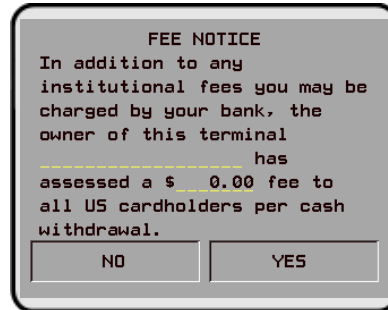

CUSTOM-D

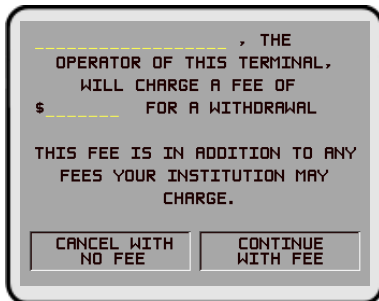

CUSTOM-E

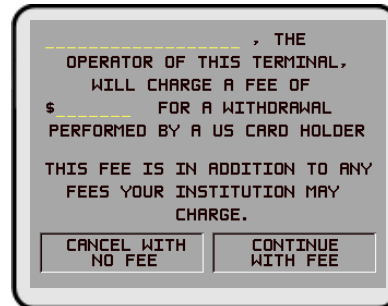

CUSTOM-F

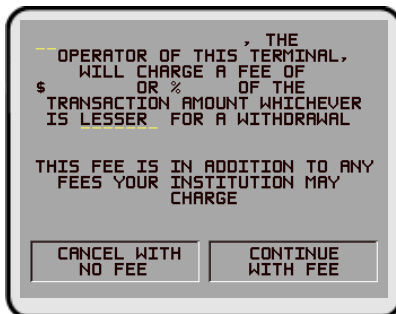

CUSTOM-G

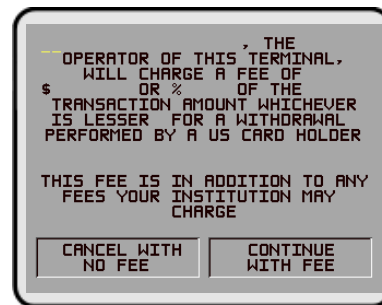

CUSTOM-H

ERROR CONDITIONS:

There are no error conditions directly associated with this function.

SECTION 5 - MANAGEMENT FUNCTIONS

FUNCTION: WELCOME MESSAGE

FACTORY DEFAULT: 'WELCOME TO miniATM'

ACCESS INSTRUCTIONS:

- 1.) Select **TERMINAL CONFIGURATION** from the **MANAGEMENT FUNCTIONS** menu.
- 2.) Select **CHANGE MESSAGES**.
- 3.) Select **Welcome Message**.

F1 CENTER LINE
 F2 CLEAR ALL
 F3 CLEAR LINE
 F4 CASE UPPER

LEFT F6
 CENTER F7
 RIGHT F8

DESCRIPTION:

The Welcome Message consists of three lines of text that are printed at the top of the customer welcome screen. The text can be full alphanumeric text. Enter letters, numbers and punctuation as follows:

The keys along either side of the display are used with the numeric keys on the main keypad to permit entry of alphanumeric characters. The keys on the left side of the display are designated <F1> through <F4>. The keys on the right side of the display are <F6> through <F8>. The <F1> key centers the text on the line where the cursor appears. The <F2> key erases all text in the current message. <F3> clears the text on the line the cursor is currently appearing.

KEY	1	2	3	4	5	6	7	8	9	0
F4 UPPER
No Shift	1	2	3	4	5	6	7	8	9	0
F6 Left	Q	A	D	G	J	M	P	T	W	,
F7 Center	Z	B	E	H	K	N	R	U	X	.
F8 Right	Sp	C	F	I	L	O	S	V	Y	-
F4 LOWER										
No Shift	!	@	#	\$	%	^	&	*	()
F6 Left	q	a	d	g	j	m	p	t	w	'
F7 Center	z	b	c	h	k	n	r	u	x	+
F8 Right	&	c	f	i	l	o	s	v	y	=

The <F4> Key is used similarly to a CAPS LOCK key on a computer keyboard. Pressing the <F4> key toggles between uppercase and lowercase. To enter an alphabetic or punctuation character, one of the <F6> through <F8> keys must be pressed, followed by one of the numeric keys. The resultant character will be as indicated in the table. Press the <OK> key to save the changes made. If you make a mistake and want to start over, press the CANCEL key to discard any changes made to that point.

ERROR CONDITIONS:

There are no error conditions directly associated with this function.

SECTION 5 - MANAGEMENT FUNCTIONS

FUNCTION: SURCHARGE OWNER

FACTORY DEFAULT: NONE

ACCESS INSTRUCTIONS:

- 1.) Select **TERMINAL CONFIGURATION** from the **MANAGEMENT FUNCTIONS** menu.
- 2.) Select **CHANGE MESSAGES**.
- 3.) Select **SURCHARGE OWNER**.



DESCRIPTION:

The name of the **SURCHARGE OWNER** is stored in the terminal and printed on the Receipt Printer Test Report. The name of the **SURCHARGE OWNER** is entered directly into the terminal.

To enter a digit 0-9, simply press the key that has that digit. To enter a letter, first press the **<BLUE>** key, then press the key that has the letter you want on it. The first press of the key will display the first character above the number. Subsequent presses will display the characters in sequence. When the character you want is displayed, press the **<RIGHT ARROW>** key to 'lock in' the letter. If your next character is a letter, you must press the **<BLUE>** key again.

The name can be up to 18 characters long.

ERROR CONDITIONS:

There are no error conditions directly associated with this function

SECTION 5 - MANAGEMENT FUNCTIONS

FUNCTION: EXIT MESSAGE

FACTORY DEFAULT: 'Thank's for Using miniATM'

ACCESS INSTRUCTIONS:

- 1.) Select TERMINAL CONFIGURATION from the MANAGEMENT FUNCTIONS menu.
- 2.) Select CHANGE MESSAGES.
- 3.) Select EXIT MESSAGE.

F1 CENTER LINE	LEFT F6
F2 CLEAR ALL	CENTER F7
F3 CLEAR LINE	RIGHT F8
F4 CASE UPPER	

DESCRIPTION:

The Exit Message consists of three lines of text that are printed on the terminal display at the conclusion of a transaction. The text can be full alphanumeric text. Enter letters, numbers and punctuation as follows:

The keys along either side of the display are used with the numeric keys on the main keypad to permit entry of alphanumeric characters. The keys on the left side of the display are designated <F1> through <F4>. The keys on the right side of the display are <F6> through <F8>. The <F1> key centers the text on the line where the cursor appears. The <F2> key erases all text in the current message. <F3> clears the text on the line the cursor is currently appearing.

KEY	1	2	3	4	5	6	7	8	9	0
F4 UPPER										
No Shift	1	2	3	4	5	6	7	8	9	0
F6 Left	Q	A	D	G	J	M	P	T	W	,
F7 Center	Z	B	E	H	K	N	R	U	X	.
F8 Right	Sp	C	F	I	L	O	S	V	Y	-
F4 LOWER										
No Shift	!	@	#	\$	%	^	&	*	()
F6 Left	q	a	d	g	j	m	p	t	w	'
F7 Center	z	b	c	h	k	n	r	u	x	+
F8 Right	&	c	f	i	l	o	s	v	y	=

The <F4> Key is used similarly to a CAPS LOCK key on a computer keyboard. Pressing the <F4> key toggles between uppercase and lowercase. To enter an alphabetic or punctuation character, one of the <F6> through <F8> keys must be pressed, followed by one of the numeric keys. The resultant character will be as indicated in the table. Press the <OK> key to save the changes made. If you make a mistake and want to start over, press the CANCEL key to discard any changes made to that point.

ERROR CONDITIONS:

There are no error conditions directly associated with this function.

SECTION 5 - MANAGEMENT FUNCTIONS

FUNCTION: STORE MESSAGE

FACTORY DEFAULT: SEE NOTE

ACCESS INSTRUCTIONS:

- 1.) Select TERMINAL CONFIGURATION from the MANAGEMENT FUNCTIONS menu.
- 2.) Select CHANGE MESSAGES.
- 3.) Select STORE MESSAGE.

F1 CENTER LINE F2 CLEAR ALL F3 CLEAR LINE F4 CASE UPPER	LEFT F6 CENTER F7 RIGHT F8
--	----------------------------------

DESCRIPTION:

The STORE MESSAGE consists of four lines of text that are printed on the customer receipt. The text can be full alphanumeric text. Enter letters, numbers and punctuation as follows:

KEY	1	2	3	4	5	6	7	8	9	0
F4 UPPER
No Shift	1	2	3	4	5	6	7	8	9	0
F6 Left	Q	A	D	G	J	M	P	T	W	,
F7 Center	Z	B	E	H	K	N	R	U	X	.
F8 Right	Sp	C	F	I	L	O	S	V	Y	-
F4 LOWER										
No Shift	!	@	#	\$	%	^	&	*	()
F6 Left	q	a	d	g	j	m	p	t	w	'
F7 Center	z	b	c	h	k	n	r	u	x	+
F8 Right	&	c	f	i	l	o	s	v	y	=

The keys along either side of the display are used with the numeric keys on the main keypad to permit entry of alphanumeric characters. The keys on the left side of the display are designated <F1> through <F4>. The keys on the right side of the display are <F6> through <F8>. The <F1> key centers the text on the line where the cursor appears. The <F2> key erases all text in the current message. <F3> clears the text on the line the cursor is currently appearing.

The <F4> Key is used similarly to a CAPS LOCK key on a computer keyboard. Pressing the <F4> key toggles between uppercase and lowercase. To enter an alphabetic or punctuation character, one of the <F6> through <F8> keys must be pressed, followed by one of the numeric keys. The resultant character will be as indicated in the table. Press the <OK> key to save the changes made. If you make a mistake and want to start over, press the CANCEL key to discard any changes made to that point.

NOTE: ‘*THIS IS LINE (1-4) OF THE STORE MESSAGE*’

ERROR CONDITIONS:

There are no errors directly associated with this function.

SECTION 5 - MANAGEMENT FUNCTIONS

FUNCTION: TERMINAL OWNER

FACTORY DEFAULT: NONE

ACCESS INSTRUCTIONS:

- 1.) Select **TERMINAL CONFIGURATION** from the **MANAGEMENT FUNCTIONS** menu.
- 2.) Select **CHANGE MESSAGES**.
- 3.) Select **TERMINAL OWNER**.



DESCRIPTION:

The name of the **TERMINAL OWNER** is stored in the terminal and displayed to the customer in the surcharge warning message. The name is entered directly into the terminal.

To enter a digit 0-9, simply press the key that has that digit. To enter a letter, first press the <BLUE> key, then press the key that has the letter you want on it. The first press of the key will display the first character above the number. Subsequent presses will display the characters in sequence. When the character you want is displayed, press the <RIGHT ARROW> key to 'lock in' the letter. If your next character is a letter, you must press the <BLUE> key again.

The name can be up to 18 characters long.

ERROR CONDITIONS:

There are no error conditions directly associated with this function.

SECTION 5 - MANAGEMENT FUNCTIONS

FUNCTION: TERMINAL PARAMETERS

FACTORY DEFAULT: N/A

ACCESS INSTRUCTIONS:

- 1.) Select **TERMINAL CONFIGURATION** from the **MANAGEMENT FUNCTIONS** menu.
- 2.) Select **SET TERMINAL PARAMETERS**.

DESCRIPTION:

Selecting **SET TERMINAL PARAMETERS** from the **TERMINAL CONFIGURATION** menu allows the following Cash Dispenser operating parameters to be viewed or changed:

- 1.) **SET TERMINAL #**
- 2.) **RESET SEQ #**
- 3.) **SURCHARGE MODE**
- 4.) **CASSETTE SETUP**
- 5.) **KEY MANAGEMENT**
- 6.) **TELEPHONE**
- 7.) **MORE**

ERROR CONDITIONS:

There are no error conditions directly associated with this function.

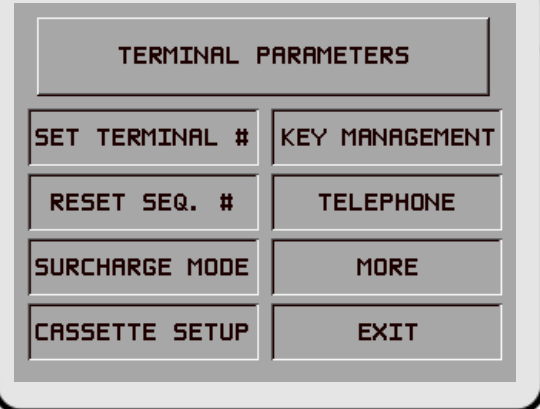

SECTION 5 - MANAGEMENT FUNCTIONS

FUNCTION: SET TERMINAL

FACTORY DEFAULT: NONE

ACCESS INSTRUCTIONS:

- 1.) Select TERMINAL CONFIGURATION from the MANAGEMENT FUNCTIONS menu.
- 2.) Select SET TERMINAL PARAMETERS.
- 3.) Choose the SET TERMINAL # option.

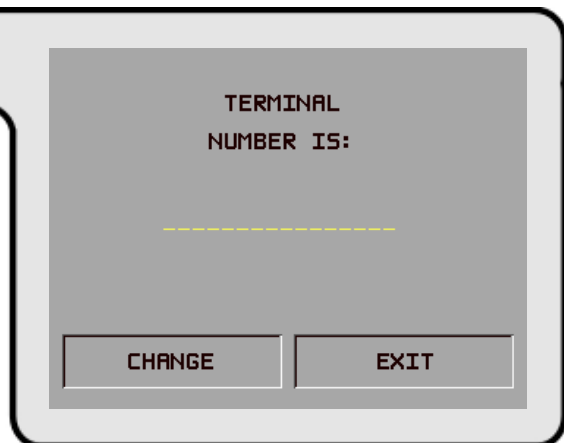

DESCRIPTION:

The TERMINAL # is a unique string of characters provided by your processor to identify the Cash Dispenser when a transaction is taking place. It can contain numbers and letters.

This parameter **MUST** be set before the Cash Dispenser can go on-line AND before the communications key can be downloaded.

When this function is selected, the current TERMINAL # is displayed. If it is to be changed, select CHANGE.

To enter a digit 0-9, press the key that has that digit. To enter a letter, first press the <BLUE> key, then press the key that has the letter you want on it. The first press of the key will display the first character above the number. Subsequent presses will display the characters in sequence. When the character you want is displayed, press the <RIGHT ARROW> key to 'lock in' the letter. If your next character is a letter, you must press the <BLUE> key again.

When you have entered all of the characters, press the <OK> key.

ERROR CONDITIONS:

The Cash Dispenser will not function on-line without a valid TERMINAL #.

SECTION 5 - MANAGEMENT FUNCTIONS

FUNCTION: RESET SEQ #

FACTORY DEFAULT: N/A

ACCESS INSTRUCTIONS:

- 1.) Select **TERMINAL CONFIGURATION** from the **MANAGEMENT FUNCTIONS** menu.
- 2.) Select **SET TERMINAL PARAMETERS**.
- 3.) Choose the **RESET SEQ #** option.

TERMINAL PARAMETERS	
SET TERMINAL #	KEY MANAGEMENT
RESET SEQ. #	TELEPHONE
SURCHARGE MODE	MORE
CASSETTE SETUP	EXIT

DESCRIPTION:

Select the **RESET SEQ. #** option from the **TERMINAL PARAMETER** menu to reset the sequence number that is printed on the journal printout and receipt to **'00000000'**.

Resetting the **SEQUENCE #** is an operation that should usually be performed at the request of your processor. Use of this function is not required during normal operation.

ERROR CONDITIONS:

There are no error conditions directly associated with this function.

SECTION 5 - MANAGEMENT FUNCTIONS

FUNCTION: SURCHARGE MODE

FACTORY DEFAULT: N/A

ACCESS INSTRUCTIONS:

- 1.) Select **TERMINAL CONFIGURATION** from the **MANAGEMENT FUNCTIONS** menu.
- 2.) Select **SET TERMINAL PARAMETERS**.
- 3.) Choose the **SURCHARGE MODE** option.

SURCHARGE MODE: **DISABLE**
AMOUNT = \$

SURCHARGE PERCENT	
ENABLE	BLOCK ISO'S
DISABLE	SURCHARGE AMOUNT
SURCHARGE LOCATION	EXIT

DESCRIPTION:

Selecting the **SURCHARGE MODE** option from the **SET TERMINAL PARAMETERS** menu allows the terminal operator or service technician to change the following surcharge options:

- 1.) **SURCHARGE PERCENT**
- 2.) **ENABLE/DISABLE SURCHARGE MODE**
- 3.) **SURCHARGE LOCATION**
- 4.) **BLOCK ISO'S**
- 5.) **SURCHARGE AMOUNT**

ERROR CONDITIONS:

There are no error conditions directly associated with this function.

SECTION 5 - MANAGEMENT FUNCTIONS

FUNCTION: SURCHARGE PERCENT

FACTORY DEFAULT: '0' / LESSER

ACCESS INSTRUCTIONS:

- 1.) Select TERMINAL CONFIGURATION from the MANAGEMENT FUNCTIONS menu.
- 2.) Select SET TERMINAL PARAMETERS.
- 3.) Choose the SURCHARGE MODE option.
- 4.) Select SURCHARGE PERCENT.

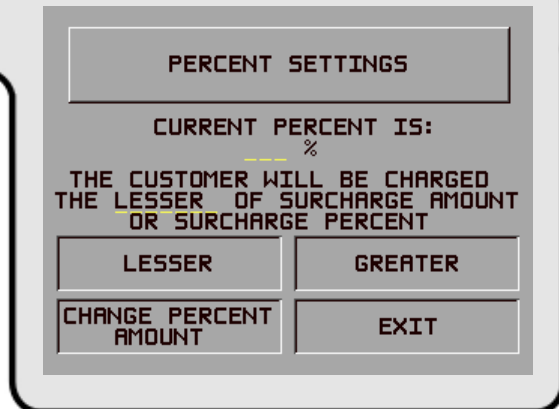

DESCRIPTION:

The SURCHARGE PERCENT option on the SURCHARGE MODE screen brings up the PERCENT SETTINGS screen, which enables you to enter a specific surcharge percentage amount and to choose the LESSER or GREATER comparison option that is applicable to the surcharge. ***Remember that these options must conform to the processor's requirements or other applicable commerce regulations.***

To enter a surcharge percent value press the CHANGE PERCENT AMOUNT key. Enter the applicable percentage value (from 1 and 99 percent) and press "OK".

If the processor or other authority requires that the surcharge be the *lesser* of either a fixed surcharge amount (entered using the Surcharge Amount function) or surcharge percentage, select the LESSER option. If the surcharge must be the *greater* of either the surcharge amount or surcharge percentage, select the GREATER option. ***Failure to select the correct comparison option can cause an incorrect surcharge value to be reported to the customer.***

The surcharge percent value is stored in the terminal and will be displayed to the customer on the applicable surcharge message screen.

ERROR CONDITIONS:

If a fixed surcharge amount is to be used (surcharge percent not used) you must ensure the surcharge comparison option is set to GREATER and the surcharge percent is set to zero (0). This will ensure that only the fixed surcharge amount value will be displayed to the customer. ***Failure to do so can cause an incorrect surcharge value to be reported to the customer.***

SECTION 5 - MANAGEMENT FUNCTIONS

FUNCTION: ENABLE/DISABLE SURCHARGE

FACTORY DEFAULT: DISABLED

ACCESS INSTRUCTIONS:

- 1.) Select **TERMINAL CONFIGURATION** from the **MANAGEMENT FUNCTIONS** menu.
- 2.) Select **SET TERMINAL PARAMETERS**.
- 3.) Choose the **SURCHARGE MODE** option.
- 4.) Select **ENABLE** or **DISABLE**, as appropriate.

SURCHARGE MODE: DISABLE	
AMOUNT = \$	
SURCHARGE PERCENT	
ENABLE	BLOCK ISO'S
DISABLE	SURCHARGE AMOUNT
SURCHARGE LOCATION	EXIT

DESCRIPTION:

Some networks allow a surcharge, or terminal fee, to be imposed on withdrawal transactions. If surcharges are in use on your network, you are required to notify the customer of an additional fee before the transaction is processed. He or she must be given a chance to cancel the transaction. Setting the **SURCHARGE MODE** to **ENABLED** will cause a surcharge notification screen to be displayed after the customer's card is inserted into the unit. The customer is given the choice of canceling the transaction at no charge or of continuing.

If your network does not allow surcharges, select the **DISABLE** option to turn off presentation of the surcharge notification message.

ERROR CONDITIONS:

If a fixed surcharge amount is to be used (surcharge percent not used) you must ensure the surcharge comparison parameter is set to **GREATER**. *Failure to do so can cause an incorrect surcharge value to be reported to the customer.*

SECTION 5 - MANAGEMENT FUNCTIONS

FUNCTION: SURCHARGE LOCATION

FACTORY DEFAULT: BEGINNING

ACCESS INSTRUCTIONS:

- 1.) Select **TERMINAL CONFIGURATION** from the **MANAGEMENT FUNCTIONS** menu.
- 2.) Select **SET TERMINAL PARAMETERS**.
- 3.) Choose the **SURCHARGE MODE** option.
- 4.) Choose the **SURCHARGE LOCATION** option.

DESCRIPTION:

The **SURCHARGE LOCATION** function determines where the terminal user is presented with the surcharge notification message. The surcharge notification message informs the customer about any surcharge that is applicable to the transaction they are completing. When the message appears the terminal user is given the option of accepting the surcharge and continuing the transaction, or canceling the transaction without incurring any charges. The surcharge amount identified in the notification message does not include any additional charges that the bank sponsoring the card may add to the cost of processing a transaction.

Selecting the **BEGINNING** option displays the applicable surcharge notification message immediately after the terminal user removes the card from the card reader and before their PIN is entered into the terminal.

Selecting the **ENDING** option displays the surcharge notification message after the terminal user has selected an amount from the **FAST CASH** menu or entered the amount of the withdrawal and pressed the “<OK>” key to complete the transaction.

ERROR CONDITIONS:

There are no error conditions directly associated with this function.

SURCHARGE MESSAGE LOCATION

BEGINNING

BEGINNING

ENDING

EXIT

SECTION 5 - MANAGEMENT FUNCTIONS

FUNCTION: BLOCK ISO'S

FACTORY DEFAULT: NONE

ACCESS INSTRUCTIONS:

- 1.) Select **TERMINAL CONFIGURATION** from the **MANAGEMENT FUNCTIONS** menu.
- 2.) Select **SET TERMINAL PARAMETERS**.
- 3.) Choose the **SURCHARGE MODE** option.
- 4.) Choose the **BLOCK ISO'S** option.

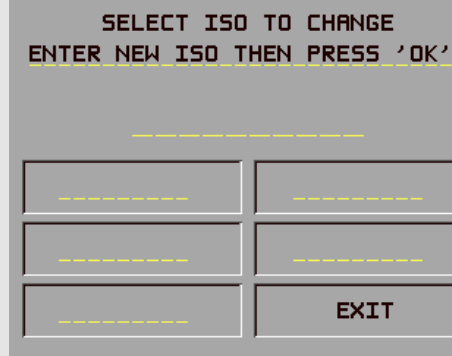

SELECT ISO TO CHANGE
ENTER NEW ISO THEN PRESS 'OK'

DESCRIPTION:

This function is used to block surcharging and to disable the display of surcharge messages for transactions that use a particular financial institution's ATM or Credit Card. Entering the financial institution's unique ISO (International Standards Organization) Number on this screen enables the function.

The terminal can store up to 100 ISO numbers to block at one time; however, only 5 numbers can be entered using the **BLOCK ISO'S** screen. Additional ISO numbers (up to the 100-number limit) must be downloaded to the terminal using Triton Connect management software.

From 1 to 9 digits may be used. The terminal will compare the card number to all current ISO numbers to the length of each number. For example, three ISO numbers are entered, including '581234', '46', and '3785'. Any card beginning with '46' would match and cause the surcharge notification message to be suppressed (if surcharging were enabled). A card with the starting number '581235' would not match and therefore a surcharge message would appear. With this technique cards from many issuers can be supported. The more digits entered the fewer the number of different cards that will match.

If a card number matches an ISO number to be blocked, the customer will not see the surcharge notification screen. The processor will also be notified of this in the transaction. Most processors support this function. Before enabling this feature, check to make sure your particular processor supports it. Otherwise, your terminal could be in violation of network rules and be sanctioned.

SECTION 5 - MANAGEMENT FUNCTIONS

To enter or change an ISO go to the SELECT ISO TO CHANGE screen and perform the following:

- 1.) Press the Screen Key next to the block where the new ISO will be entered or an ISO changed.
- 2.) Enter the ISO number (up to six digits in length).
- 3.) Press the “<OK>” key.

If more than one ISO must be entered repeat steps 1 through 3 until all ISO are entered (up to five ISO numbers may be entered using this screen).

ERROR CONDITIONS:

There are no error conditions directly associated with this function.

SECTION 5 - MANAGEMENT FUNCTIONS

FUNCTION: SURCHARGE AMOUNT

FACTORY DEFAULT: '\$0.00'

ACCESS INSTRUCTIONS:

- 1.) Select **TERMINAL CONFIGURATION** from the **MANAGEMENT FUNCTIONS** menu.
- 2.) Select **SET TERMINAL PARAMETERS**.
- 3.) Choose the **SURCHARGE MODE** option.
- 4.) Choose the **SURCHARGE AMOUNT** option.

ENTER NEW AMOUNT AND PRESS 'OK'	
SURCHARGE MODE: ENABLE	
AMOUNT = \$ 0.00	
SURCHARGE PERCENT	
ENABLE	BLOCK ISO'S
DISABLE	SURCHARGE AMOUNT
SURCHARGE LOCATION	EXIT

DESCRIPTION:

The surcharge amount will be entered directly on the **SURCHARGE MODE** screen. The value you enter here will be displayed to the user in the surcharge notification message that was selected via the **SURCHARGE OPTIONS SCREEN** function. Press the **SURCHARGE AMOUNT** menu key. The **ENTER NEW AMOUNT AND PRESS 'OK'** prompt will appear. Enter a new value. This value will appear in the "AMOUNT = _ _ _ _ _" field that will appear on the **SURCHARGE MODE** screen. The value will be stored in the terminal and displayed to the customer in the surcharge notification message. See **ERROR CONDITIONS:** for additional information on this feature.

ERROR CONDITIONS:

It is important to understand that processor or network rules and/or applicable commerce laws ultimately determine the type and amount of any surcharge that may be assessed against a transaction. The surcharge values that you enter will be displayed to the customer and **MUST** match the actual surcharge rates established by your processor or other applicable regulatory agencies!

Manually changing the **SURCHARGE AMOUNT** to a lower or higher amount does not automatically change the surcharge collected by the processor for a transaction. It will only change the surcharge amount displayed during the surcharge-warning message when it is shown to the customer and not the actual fee collected for the transaction.

SECTION 5 - MANAGEMENT FUNCTIONS

FUNCTION: CASSETTE SETUP

FACTORY DEFAULT: N/A

- 1.) Select **TERMINAL CONFIGURATION** from the **MANAGEMENT FUNCTIONS** menu.
- 2.) Select **SET TERMINAL PARAMETERS**.
- 3.) Select **CASSETTE SETUP**.

DESCRIPTION:

Selecting **CASSETTE SETUP** at the **TERMINAL PARAMETERS** menu allows the terminal operator to view and change the following parameters:

- 1.) **INTERNATIONAL CURRENCY**
- 2.) **MAXIMUM AMOUNT**
- 3.) **MULTIPLE AMOUNT**
- 4.) **EXTENDED AMOUNT**
- 5.) **FAST CASH AMOUNT**

ERROR CONDITIONS:

There are no errors directly associated with the **WITHDRAWAL AMOUNTS** function.

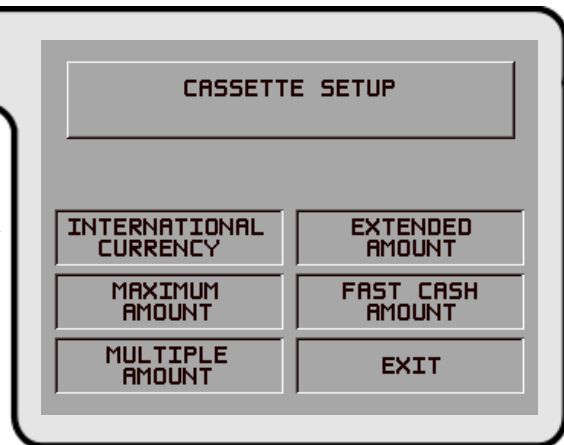

SECTION 5 - MANAGEMENT FUNCTIONS

FUNCTION: INTERNATIONAL CURRENCY

FACTORY DEFAULT: COUNTRY-SPECIFIC

ACCESS INSTRUCTIONS:

- 1.) Select TERMINAL CONFIGURATION from the MANAGEMENT FUNCTIONS menu.
- 2.) Select SET TERMINAL PARAMETERS.
- 3.) Select CASSETTE SETUP.
- 4.) Choose the INTERNATIONAL CURRENCY option.

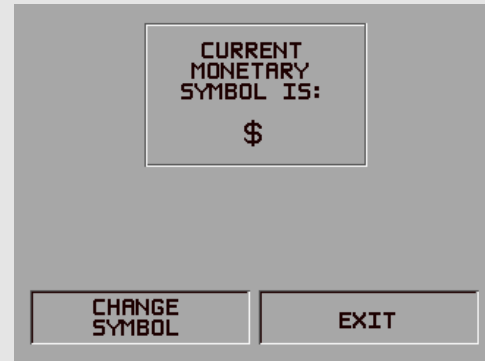

DESCRIPTION:

This feature will allow operator personnel to select one of nine possible monetary symbols (C, ¢, \$, f, L, P_t, £, Q, ¥) that describe the type of currency that will be dispensed by the Cash Dispenser. The default symbol can be viewed and changed through the terminals' Management Functions.

Monetary symbols for use with following currencies are supported by the Cash Dispenser:

- 1.) C - The symbol for the Colon (Costa Rica)
- 2.) ¢ - The symbol for the Colon (El Salvador)
- 3.) \$ - The symbol of the Dollar and Peso
- 4.) f - The symbol for the Franc
- 5.) L - The symbol for the Lempira
- 6.) P_t - The symbol for the Peseta
- 7.) £ - The symbol for the Pound
- 8.) Q - The symbol for the Quetzal
- 9.) ¥ - The symbol for the Yen

When the INTERNATIONAL CURRENCY menu is displayed, press the screen key next to the CHANGE SYMBOL option until the desired currency symbol is displayed. Press EXIT to make that symbol the default symbol displayed on the terminal.

ERROR CONDITIONS:

There are no error conditions directly associated with this function.

SECTION 5 - MANAGEMENT FUNCTIONS

FUNCTION: MAXIMUM AMOUNT

FACTORY DEFAULT: '\$500.00'

ACCESS INSTRUCTIONS:

- 1.) Select **TERMINAL CONFIGURATION** from the **MANAGEMENT FUNCTIONS** menu.
- 2.) Select **SET TERMINAL PARAMETERS**.
- 3.) Select **CASSETTE SETUP**.
- 4.) Choose the **MAXIMUM AMOUNT** option.

MAXIMUM WITHDRAW LIMIT

\$.00

ENTER NEW AMOUNT & PRESS 'OK'

CHANGE EXIT

DESCRIPTION:

The maximum cash withdrawal limit must be set in the Cash Dispenser before any transactions can be completed. This number is the largest dollar amount allowed for a withdrawal transaction. It can be set from 1 to 999999 in increments of 1 and it must be an even multiple of the denomination that is in the cassette. Factory default is set to **\$500.00**. The value is dollar amount only; no cents are allowed.

Whenever a withdrawal amount is entered or selected (via the **FAST CASH** option), the amount entered or selected is compared to this amount. If the entry is larger, an error message warns the user and displays the maximum allowable amount.

This amount **DOES NOT** override any maximum set by a network. The transaction will be sent to the network if the amount entered or selected is less than or equal to the maximum. *The network must still approve the amount.*

ERROR CONDITIONS:

The **MAXIMUM AMOUNT** cannot be more than **20 times** the **MULTIPLE AMOUNT**.

SECTION 5 - MANAGEMENT FUNCTIONS

FUNCTION: MULTIPLE AMOUNT

FACTORY DEFAULT: '\$0.00'

ACCESS INSTRUCTIONS:

- 1.) Select **TERMINAL CONFIGURATION** from the **MANAGEMENT FUNCTIONS** menu.
- 2.) Select **SET TERMINAL PARAMETERS**.
- 3.) Select **CASSETTE SETUP**.
- 4.) Choose the **MULTIPLE AMOUNT** option.

MULTIPLE AMOUNT

\$.00

ENTER NEW AMOUNT & PRESS 'OK'

CHANGE EXIT

DESCRIPTION:

The **MULTIPLE AMOUNT** must be set in the Cash Dispenser before any transactions can be processed. This number is the denomination of the currency installed in the currency cassette. It can be set to 10, 20, 50, or 100.

Whenever a withdrawal transaction is performed, the amount entered or selected is compared to the **MULTIPLE AMOUNT**. If the entry is not an even multiple of this amount, an error warns the terminal user and displays the current multiple amount.

ERROR CONDITIONS:

If the **MULTIPLE AMOUNT** is not set correctly, the terminal will respond by going into Configuration Error 186, **BILL SIZE NOT CONFIGURED CORRECTLY**. To correct the error condition enter the management functions and configure the bill size (**MULTIPLE AMOUNT**) to the size of the bill in the cassette.

SECTION 5 - MANAGEMENT FUNCTIONS

FUNCTION: EXTENDED AMOUNT

FACTORY DEFAULT: DISABLED

ACCESS INSTRUCTIONS:

- 1.) Select **TERMINAL CONFIGURATION** from the **MANAGEMENT FUNCTIONS** menu.
- 2.) Select **SET TERMINAL PARAMETERS**.
- 3.) Select **CASSETTE SETUP**.
- 4.) Choose the **EXTENDED AMOUNT** option.

DESCRIPTION:

The standard length of a currency amount entry field is 8 digits. In some applications this length is insufficient to allow the entry of the full range of customer transaction values in the local currency type. This feature allows the selection of 12-digit currency fields for those applications that require it.

To activate 12-digit field lengths, select the **ENABLE** option. To return to 8-digit field lengths, choose the **DISABLE** option.

ERROR CONDITIONS:

There are no error conditions directly associated with this function.

ENABLING THE EXTENDED AMOUNT
WILL INCREASE THE TRANSFER
FIELD FROM 8 TO 12 DIGITS.

CAUTION

ONLY USE THE EXTENDED AMOUNT
IF YOUR PROCESSOR CAN ACCEPT
THIS PROTOCOL.

EXTENDED AMOUNTS ARE: **DISABLED**

ENABLE

DISABLE

EXIT

SECTION 5 - MANAGEMENT FUNCTIONS

FUNCTION: FAST CASH AMOUNT

FACTORY DEFAULT: PROCESSOR-SPECIFIC

ACCESS INSTRUCTIONS:

- 1.) Select **TERMINAL CONFIGURATION** from the **MANAGEMENT FUNCTIONS** menu.
- 2.) Select **SET TERMINAL PARAMETERS**.
- 3.) Select **CASSETTE SETUP**.
- 4.) Choose the **FAST CASH AMOUNT** option.

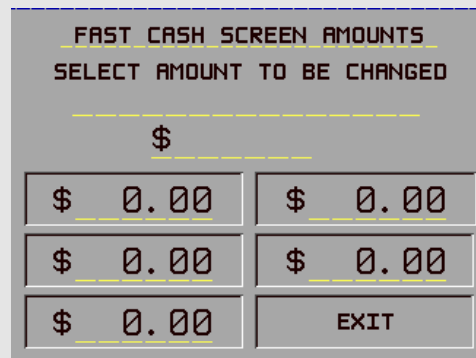

DESCRIPTION:

During a withdrawal transaction the **FAST CASH** screen prompts the customer to select the amount of the withdrawal from a list of five convenient amounts. These amounts are entered by the terminal operator using the **FAST CASH AMOUNT** function. Up to six digits (more with software versions that support extended field lengths) can be entered into any data field accepting a monetary value.

Selecting this function displays the **FAST CASH SCREEN AMOUNTS** screen. Press the screen key next to the amount to be changed, and it will begin to blink. Enter the new amount (whole dollar amount only), and then press the <OK> key. The value will replace the blinking amount.

The amounts entered must be even multiples of the denomination in the cassette. The amounts do not have to be in any particular order, although typically, they increase in value moving from upper left and down, then upper right and down. *DO NOT enter an amount that is larger than the MAXIMUM WITHDRAWAL AMOUNT.*

ERROR CONDITIONS:

There are no error conditions directly associated with this function.

SECTION 5 - MANAGEMENT FUNCTIONS

FUNCTION: KEY MANAGEMENT

FACTORY DEFAULT: N/A

ACCESS INSTRUCTIONS:

- 1.) Select TERMINAL CONFIGURATION from the MANAGEMENT FUNCTIONS menu.
- 2.) Select SET TERMINAL PARAMETERS.
- 3.) Choose the KEY MANAGEMENT option.

KEY MANAGEMENT	
ENTER MAC MASTER KEY	ENTER MAC WORKING KEY
ENTER PIN MASTER KEY	ENTER PIN WORKING KEY
INJECT MASTER KEYS	DOWNLOAD WORKING KEYS
EXIT	

DESCRIPTION:

The KEY MANAGEMENT function provides access to Cash Dispenser functions that control the method of entry for the Master Key and the Comms (Communications) Key. The functions accessed through this menu are listed below:

- 1.) ENTER MAC MASTER KEY
- 2.) ENTER PIN MASTER KEY (Formerly known as the “MASTER KEY”)
- 3.) INJECT MASTER KEYS
- 4.) ENTER MAC WORKING KEY
- 5.) ENTER PIN WORKING KEY (Formerly known as the “COMMS KEY”)
- 6.) DOWNLOAD WORKING KEYS

ERROR CONDITIONS:

IMPORTANT: The MAC MASTER KEY must be entered before the MAC Working key. Likewise, the PIN MASTER KEY must be entered before the PIN Working key.

SECTION 5 - MANAGEMENT FUNCTIONS

FUNCTION: ENTER MAC MASTER KEY

FACTORY DEFAULT: PROCESSOR-SPECIFIC

ACCESS INSTRUCTIONS:

- 1.) Select **TERMINAL CONFIGURATION** from the **MANAGEMENT FUNCTIONS** menu.
- 2.) Select **SET TERMINAL PARAMETERS**.
- 3.) Select **KEY MANAGEMENT**.
- 4.) Choose the **ENTER MAC MASTER KEY** option.

ENTER 16 CHARACTER MAC MASTER
KEY, THEN PRESS OK

RE-ENTER MAC MASTER KEY.

DESCRIPTION:

NOTE: The MAC MASTER KEY feature is applicable only to terminals using Triton Standard ATM software and a Secure Pin Entry Device (SPED) module.

IMPORTANT: The MAC MASTER KEY must be entered before the MAC Working key.

MAC is an acronym for Message Authentication Code. The MAC MASTER KEY is used to protect the MAC WORKING KEY during manual entry or downloading of the working key. The MAC MASTER KEY is a 16-character string, consisting of the digits 0-9 and the letters A-F. Your processor must provide you with the MAC MASTER KEY. If a MAC authentication attempt on a message fails, the message will fail. This is a security precaution.

For security reasons, when entering this key, a '*' is displayed in place of the actual character. Since it is not possible to view the key while it is entered, the key must be entered in twice to make sure it was entered properly.

To enter a digit 0-9, simply press the key that has that digit, and a '*' will appear. To enter the letters A-F, first press the <BLUE> key, then press the key that has the letter you want on it. The first press of the key will display the first character above the number. Subsequent presses will display the characters in sequence. When the character you want is displayed, press the <RIGHT ARROW> key to 'lock in' the letter. If your next character is a letter, you must press the <BLUE> key again. Press the <CHANGE> key to clear the entry and start over. Press the <LEFT ARROW> key to back up and erase a character.

SECTION 5 - MANAGEMENT FUNCTIONS

Normally, the MAC MASTER KEY contains only one part. However, some keys may contain multiple parts. If this is the case, separate individuals will hold the parts. If your key has multiple parts you must answer the question “ANOTHER KEY PART?”, with a YES until all parts are entered.

The CHECK DIGIT that appears after all parts of the MAC MASTER KEY have been entered is similar to the checksum that is used to verify that the data programmed into a memory device such as an EPROM is correct. The CHECK DIGIT can be verified by doing a RECEIPT PRINTER TEST from the DIAGNOSTICS Menu and comparing the MAC MASTER KEY CHECK DIGIT on the printout to the original receipt printout from the initial terminal setup. If the CHECK DIGIT is different from the original, and the terminal is not operating correctly, the MAC MASTER KEY is corrupt and you should contact your service organization for assistance.

ERROR CONDITIONS:

If the MAC MASTER KEY is not entered correctly, no message traffic can take place, so be sure to enter the key accurately. If your second entry of the key does not match the first entry, you will be warned and allowed to start over with the first entry.

SECTION 5 - MANAGEMENT FUNCTIONS

FUNCTION: ENTER PIN MASTER KEY

FACTORY DEFAULT: PROCESSOR-SPECIFIC

ACCESS INSTRUCTIONS:

- 1.) Select TERMINAL CONFIGURATION from the MANAGEMENT FUNCTIONS menu.
- 2.) Select SET TERMINAL PARAMETERS.
- 3.) Select KEY MANAGEMENT.
- 4.) Choose the ENTER PIN MASTER KEY option.



ENTER 16 CHARACTER PIN MASTER
THEN PRESS OK

RE-ENTER PIN MASTER KEY

DESCRIPTION:

IMPORTANT: The PIN MASTER KEY must be entered before the PIN Working key.

NOTE: The PIN MASTER KEY was referred to as the MASTER KEY in previous versions of ATM software.

The PIN MASTER KEY is used to protect the PIN WORKING KEY during manual entry or downloading of the working key. This key is a 16-character string, consisting of the digits 0-9 and the letters A-F. Your processor must provide you with the PIN MASTER KEY.

For security reasons, when entering this key, a '*' is displayed in place of the actual character. Since it is not possible to view the key while it is entered, the key must be entered in twice to make sure it was entered properly.

To enter a digit 0-9, simply press the key that has that digit, and a '*' will appear. To enter the letters A-F, first press the <BLUE> key, then press the key that has the letter you want on it. The first press of the key will display the first character above the number. Subsequent presses will display the characters in sequence. When the character you want is displayed, press the <RIGHT ARROW> key to 'lock in' the letter. If your next character is a letter, you must press the <BLUE> key again. Press the <CHANGE> key to clear the entry and start over. Press the <LEFT ARROW> key to back up and erase a character.

Normally, the PIN MASTER KEY contains only one part. However, some keys may contain multiple parts. If this is the case, separate individuals will hold the parts. If your key has multiple parts you must answer the question "ANOTHER KEY PART?", with a YES until all parts are entered.

SECTION 5 - MANAGEMENT FUNCTIONS

The CHECK DIGIT that appears after all parts of the PIN MASTER KEY have been entered is similar to the checksum that is used to verify that the data programmed into a memory device such as an EPROM is correct. The CHECK DIGIT can be verified by doing a RECEIPT PRINTER TEST from the DIAGNOSTICS Menu and comparing the PIN MASTER KEY CHECK DIGIT on the printout to the original receipt printout from the initial terminal setup. If the CHECK DIGIT is different from the original, and the terminal is not operating correctly, the PIN MASTER KEY is corrupt, and you should contact your service organization for assistance.

ERROR CONDITIONS:

If the PIN MASTER KEY is not entered correctly, no message traffic can take place, so be sure to enter the key accurately. If your second entry of the key does not match the first entry, you will be warned and allowed to start over with the first entry.

SECTION 5 - MANAGEMENT FUNCTIONS

FUNCTION: INJECT MASTER KEY

FACTORY DEFAULT: N/A

ACCESS INSTRUCTIONS:

- 1.) Select **TERMINAL CONFIGURATION** from the **MANAGEMENT FUNCTIONS** menu.
- 2.) Select **SET TERMINAL PARAMETERS**.
- 3.) Select **KEY MANAGEMENT**.
- 4.) Choose the **INJECT MASTER KEY** option.



WAITING FOR KEY INJECTION

PRESS CANCEL TO QUIT

DESCRIPTION:

The **INJECT MASTER KEY** function is used in conjunction with a PC (Personnel Computer) and a special floppy disk to inject the master key from the PC into one or more terminals. Selecting **INJECT MASTER KEY** will cause the terminal to prepare for the load of the master key from the PC, using a serial data cable.

IMPORTANT: The **MASTER KEY** must always be loaded before the **COMMS** key!

ERROR CONDITIONS:

Do not connect the load port on the Cash Dispenser to the parallel (printer) port of the PC!

SECTION 5 - MANAGEMENT FUNCTIONS

FUNCTION: ENTER MAC WORKING KEY

FACTORY DEFAULT: PROCESSOR-SPECIFIC

ACCESS INSTRUCTIONS:

- 1.) Select **TERMINAL CONFIGURATION** from the **MANAGEMENT FUNCTIONS** menu.
- 2.) Select **SET TERMINAL PARAMETERS**.
- 3.) Select **KEY MANAGEMENT**.
- 4.) Choose the **ENTER MAC WORKING KEY** option.



ENTER 16 CHARACTER MAC WORKING
KEY, THEN PRESS 'OK'

RE-ENTER MAC WORKING KEY.

DESCRIPTION:

MAC is an acronym for Message Authentication Code. The **MAC WORKING KEY** is used to verify messages to and from the terminal. The **MAC WORKING KEY** is a 16-character string, consisting of the digits 0-9 and the letters A-F. Your processor must provide you with the **MAC WORKING KEY**. If a MAC authentication attempt on a message fails, the message will fail. This is a security precaution.

For security reasons, when entering this key, a '*' is displayed in place of the actual character. Since it is not possible to view the key while it is entered, the key must be entered in twice to make sure it was entered properly.

To enter a digit 0-9, simply press the key that has that digit, and a '*' will appear. To enter the letters A-F, first press the <BLUE> key, then press the key that has the letter you want on it. The first press of the key will display the first character above the number. Subsequent presses will display the characters in sequence. When the character you want is displayed, press the <RIGHT ARROW> key to 'lock in' the letter. If your next character is a letter, you must press the <BLUE> key again. Press the <CHANGE> key to clear the entry and start over. Press the <LEFT ARROW> key to back up and erase a character.

Normally, the **MAC WORKING KEY** contains only one part. However, some keys may contain multiple parts. If this is the case, separate individuals will hold the parts. If your key has multiple parts you must answer the question "ANOTHER KEY PART?", with a YES until all parts are entered.

SECTION 5 - MANAGEMENT FUNCTIONS

The CHECK DIGIT that appears after all parts of the MAC WORKING KEY have been entered is similar to the checksum that is used to verify that the data programmed into a memory device such as an EPROM is correct. The CHECK DIGIT can be verified by doing a RECEIPT PRINTER TEST from the DIAGNOSTICS Menu and comparing the MAC WORKING KEY CHECK DIGIT on the printout to the original receipt printout from the initial terminal setup. If the CHECK DIGIT is different from the original, and the terminal is not operating correctly, the MAC WORKING KEY is corrupt, and you should contact your service organization for assistance.

ERROR CONDITIONS:

If the MAC WORKING KEY is not entered correctly, no message traffic can take place, so be sure to enter the key accurately. If your second entry of the key does not match the first entry, you will be warned and allowed to start over with the first entry.

SECTION 5 - MANAGEMENT FUNCTIONS

FUNCTION: ENTER PIN WORKING KEY

FACTORY DEFAULT: PROCESSOR-SPECIFIC

ACCESS INSTRUCTIONS:

- 1.) Select TERMINAL CONFIGURATION from the MANAGEMENT FUNCTIONS menu.
- 2.) Select SET TERMINAL PARAMETERS.
- 3.) Select KEY MANAGEMENT.
- 4.) Choose the ENTER PIN WORKING KEY option.



ENTER 16 CHARACTER PIN WORKING
THEN PRESS 'OK'

RE-ENTER PIN WORKING KEY

DESCRIPTION:

NOTE: The PIN WORKING KEY was referred to as the COMMS KEY in previous versions of ATM software.

The PIN WORKING KEY is used to verify the customer Personal Identification Number during live transactions. This key is a 16-character string, consisting of the digits 0-9 and the letters A-F. Your processor must provide you with the PIN WORKING KEY.

For security reasons, when entering this key, a '*' is displayed in place of the actual character. Since it is not possible to view the key while it is entered, the key must be entered in twice to make sure it was entered properly.

To enter a digit 0-9, simply press the key that has that digit, and a '*' will appear. To enter the letters A-F, first press the <BLUE> key, then press the key that has the letter you want on it. The first press of the key will display the first character above the number. Subsequent presses will display the characters in sequence. When the character you want is displayed, press the <RIGHT ARROW> key to 'lock in' the letter. If your next character is a letter, you must press the <BLUE> key again. Press the <CHANGE> key to clear the entry and start over. Press the <LEFT ARROW> key to back up and erase a character.

Normally, the PIN WORKING KEY contains only one part. However, some keys may contain multiple parts. If this is the case, separate individuals will hold the parts. If your key has multiple parts you must answer the question "ANOTHER KEY PART?", with a YES until all parts are entered.

SECTION 5 - MANAGEMENT FUNCTIONS

The CHECK DIGIT that appears after all parts of the PIN WORKING KEY have been entered is similar to the checksum that is used to verify that the data programmed into a memory device such as an EPROM is correct. The CHECK DIGIT can be verified by doing a RECEIPT PRINTER TEST from the DIAGNOSTICS Menu and comparing the PIN WORKING KEY CHECK DIGIT on the printout to the original receipt printout from the initial terminal setup. If the CHECK DIGIT is different from the original, and the terminal is not operating correctly, the PIN WORKING KEY is corrupt, and you should contact your service organization for assistance.

ERROR CONDITIONS:

If the PIN WORKING KEY is not entered correctly, no message traffic can take place, so be sure to enter the key accurately. If your second entry of the key does not match the first entry, you will be warned and allowed to start over with the first entry.

SECTION 5 - MANAGEMENT FUNCTIONS

FUNCTION: DOWNLOAD WORKING KEYS

FACTORY DEFAULT: PROCESSOR-SPECIFIC

ACCESS INSTRUCTIONS:

- 1.) Select **TERMINAL CONFIGURATION** from the **MANAGEMENT FUNCTIONS** menu.
- 2.) Select **SET TERMINAL PARAMETERS**.
- 3.) Select **KEY MANAGEMENT**.
- 4.) Choose the **DOWNLOAD WORKING KEYS** option.



DESCRIPTION:

The **WORKING KEYS** are the **MAC** and **PIN WORKING KEYS**, as described earlier. They are made up of 16-character strings, consisting of the digits 0-9 and the letters A-F. Your processor may provide you with the **WORKING KEYS**, or they may be downloaded from the processor host computer.

These keys must be loaded before the Cash Dispenser can operate in a live mode.

When the **DOWNLOAD WORKING KEYS** function is run, a call is placed to your host computer, and a request is made for the keys to be sent. The host will send the keys and several other parameters (such as the surcharge amount, if applicable). Once downloaded, these parameters will remain in the Cash Dispenser, even if it is turned off.

The **TERMINAL NUMBER** and **PRIMARY PHONE NUMBER** must be set before completing this function. If they are not set correctly, the **WORKING KEYS** will not be downloaded.

ERROR CONDITIONS:

If the call cannot be completed, a warning screen will be displayed. If the function continues to fail, contact your service organization for assistance.

SECTION 5 - MANAGEMENT FUNCTIONS

FUNCTION: TELEPHONE

FACTORY DEFAULT: N/A

ACCESS INSTRUCTIONS:

- 1.) Select **TERMINAL CONFIGURATION** from the **MANAGEMENT FUNCTIONS** menu.
- 2.) Select **SET TERMINAL PARAMETERS**.
- 3.) Select **TELEPHONE**.

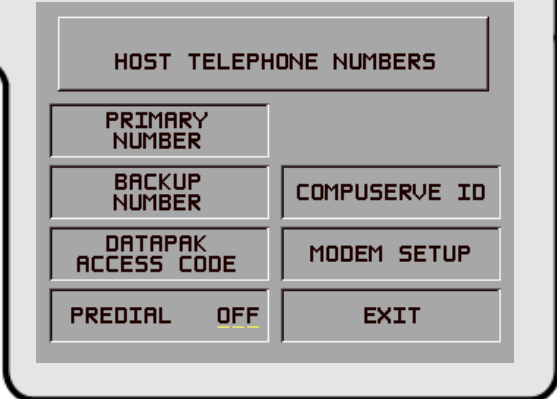

The screenshot shows a menu titled 'FUNCTION: TELEPHONE'. The menu items are arranged in a grid-like structure. At the top is 'HOST TELEPHONE NUMBERS'. Below it are 'PRIMARY NUMBER' and 'BACKUP NUMBER'. To the right of 'BACKUP NUMBER' is 'COMPUSERVE ID'. Below 'PRIMARY NUMBER' is 'DATAPAK ACCESS CODE'. To the right of 'DATAPAK ACCESS CODE' is 'MODEM SETUP'. At the bottom left is 'PREDIAL OFF' and at the bottom right is 'EXIT'.

DESCRIPTION:

The TELEPHONE function is used to set up parameters that control telephone communications between the Cash Dispenser and the Processor. The following parameters are accessed through this function.

- 1.) PRIMARY NUMBER
- 2.) BACKUP NUMBER
- 3.) DATAPAK ACCESS CODE (This feature is only available for ATMs deployed in Canada.)
- 4.) PREDIAL ON/OFF
- 5.) COMPUSERVE ID
- 6.) MODEM SETUP

ERROR CONDITIONS:

There are no error conditions directly associated with this function.

SECTION 5 - MANAGEMENT FUNCTIONS

FUNCTION: PRIMARY NUMBER

FACTORY DEFAULT: NONE

ACCESS INSTRUCTIONS:

- 1.) Select **TERMINAL CONFIGURATION** from the **MANAGEMENT FUNCTIONS** menu.
- 2.) Select **SET TERMINAL PARAMETERS**.
- 3.) Select **TELEPHONE**.
- 4.) Select the **PRIMARY NUMBER** option.

PRIMARY PHONE NUMBER

ENTER NEW NUMBER & PRESS 'OK'

CHANGE
EXIT

DESCRIPTION:

The Cash Dispenser communicates to your host processor over a dial up phone line. The phone number of the processor must be entered before live transactions can be done.

When this function is selected, the current phone number is displayed (if nothing appears on the screen, no number is set). Select **CHANGE** to blank the current entry, and then enter the desired phone number. The phone number may be up to 30 digits long. It can also contain a dialing prefix, such as a '9' for an outside line, if necessary. If you need to pause after the prefix, place a comma in the number for a two-second delay at that point. Pressing the <BLUE> key first, then the <0> key, followed by the <RIGHT ARROW> key will select the comma character. Make sure to enter the long distance prefix '1' if you are dialing an 800 number or a toll long distance number. Do not enter dashes in the number.

ERROR CONDITIONS:

The Cash Dispenser will not process transactions if the phone number has not been entered or has been entered incorrectly. In such cases error code "**185 - Phone Number Not Configured**", will be received.

SECTION 5 - MANAGEMENT FUNCTIONS

FUNCTION: BACKUP NUMBER

FACTORY DEFAULT: NONE

ACCESS INSTRUCTIONS:

- 1.) Select **TERMINAL CONFIGURATION** from the **MANAGEMENT FUNCTIONS** menu.
- 2.) Select **SET TERMINAL PARAMETERS**.
- 3.) Select **TELEPHONE**.
- 4.) Select the **BACKUP NUMBER** option.



DESCRIPTION:

The Cash Dispenser communicates with your Processors' host computer over a dial up phone line. Some processors allow a backup phone number to try if the primary number fails to connect.

When this function is selected, the current phone number is displayed (if nothing appears on the screen, no number is set). Select **CHANGE** to blank the current entry, and then enter the desired phone number. The phone number may be up to 30 digits long. It can also contain a dialing prefix, such as a '9' for an outside line, if necessary. If you need to pause after the prefix, place a comma in the number for a two-second delay at that point. Pressing the <BLUE> key first, then the <0> key, followed by the <RIGHT ARROW> select the comma. Make sure to enter the long distance prefix '1' if you are dialing an 800 number or a toll long distance number. Do not enter dashes in the number.

ERROR CONDITIONS:

There are no error conditions directly associated with this function.

SECTION 5 - MANAGEMENT FUNCTIONS

FUNCTION: DATAPAK ACCESS CODE

FACTORY DEFAULT: OFF

ACCESS INSTRUCTIONS:

- 1.) Select TERMINAL CONFIGURATION from the MANAGEMENT FUNCTIONS menu.
- 2.) Select SET TERMINAL PARAMETERS.
- 3.) Select TELEPHONE.
- 4.) Select DATAPAK ACCESS CODE.

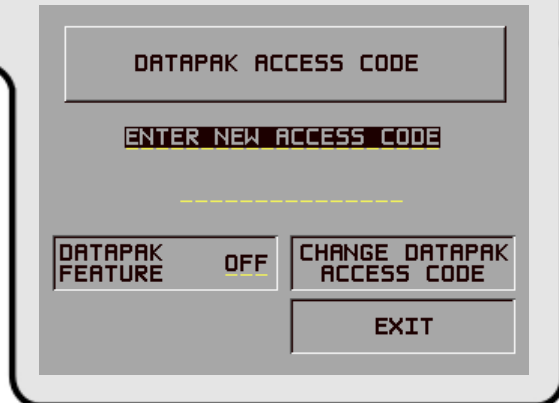

DESCRIPTION:

NOTE: This feature is only available for the Triton Standard Canadian version of ATM operating software.

This function allows you to enter the DATAPAK ACCESS CODE, and to turn the DataPak feature On or OFF. The DATAPAK ACCESS CODE is provided by the DataPak processing organization, and is an identification number which enables the DataPak processing organization to correctly identify and route data traffic between the terminal and the transaction processor.

The current state of the DATAPAK ACCESS CODE feature is shown as either ON or OFF in the label on the left-hand side of the display. Press the button next to this label to toggle the state of the feature between ON and OFF.

IMPORTANT: When using the DATAPAK communications protocol, ensure the terminal's Primary and Backup Telephone Numbers are configured to dial the DataPak processing organization (NOT the transaction processor!).

ERROR CONDITIONS:

If a DATAPAK-based communications network is being used, the DATAPAK ACCESS CODE feature must be turned ON and the code must be entered correctly to enable message traffic between the ATM and the processor to take place.

SECTION 5 - MANAGEMENT FUNCTIONS

FUNCTION: PREDIAL ON/OFF

FACTORY DEFAULT: OFF

ACCESS INSTRUCTIONS:

- 1.) Select **TERMINAL CONFIGURATION** from the **MANAGEMENT FUNCTIONS** menu.
- 2.) Select **SET TERMINAL PARAMETERS**.
- 3.) Select **TELEPHONE**.

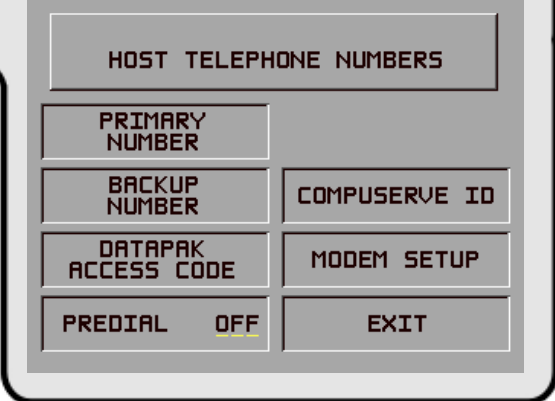

HOST TELEPHONE NUMBERS	
PRIMARY NUMBER	
BACKUP NUMBER	COMPUSERVE ID
DATAPAK ACCESS CODE	MODEM SETUP
PREDIAL OFF	EXIT

DESCRIPTION:

This function allows you to turn on or off the PREDIAL feature. When the feature is turned ON, the terminal will dial out to the processor and establish a connection as soon as the customer's ATM or credit card has been scanned by the card reader. The purpose of this mode of operation is to provide quicker processing of customer transactions. When the feature is turned OFF, the terminal will wait until the customer has selected a particular transaction before dialing out and establishing a connection with the processor.

The current state of the PREDIAL feature is shown as either ON or OFF in the label on the left-hand side of the display. Press the button next to this label to toggle the state of the feature between ON and OFF.

ERROR CONDITIONS:

There are no error conditions directly associated with this function.

SECTION 5 - MANAGEMENT FUNCTIONS

FUNCTION: COMPUSERVE ID

FACTORY DEFAULT: NONE

ACCESS INSTRUCTIONS:

- 1.) Select **TERMINAL CONFIGURATION** from the **MANAGEMENT FUNCTIONS** menu.
- 2.) Select **SET TERMINAL PARAMETERS**.
- 3.) Select **TELEPHONE**.
- 4.) Select the **COMPUSERVE ID** option.

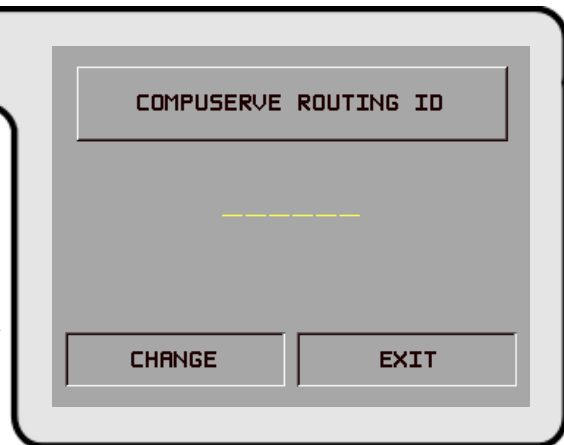

DESCRIPTION:

The CompuServe Network is used by some processors to route transactions. The COMPUSERVE ID function allows the terminal operator or a service technician to view and change the COMPUSERVE ROUTING ID number.

ERROR CONDITIONS:

When CompuServe is used as the communication media for sending and receiving transaction data to the Processor, an incorrect CompuServe ID will cause communication between the terminal and the Processor to fail. **Never change the COMPUSERVE ID unless instructed to do so by your processor.**

SECTION 5 - MANAGEMENT FUNCTIONS

FUNCTION: MODEM SETUP

FACTORY DEFAULT: N/A

ACCESS INSTRUCTIONS:

- 1.) Select **TERMINAL CONFIGURATION** from the **MANAGEMENT FUNCTIONS** menu.
- 2.) Select **SET TERMINAL PARAMETERS**.
- 3.) Select **TELEPHONE**.
- 4.) Select the **MODEM SETUP** option.

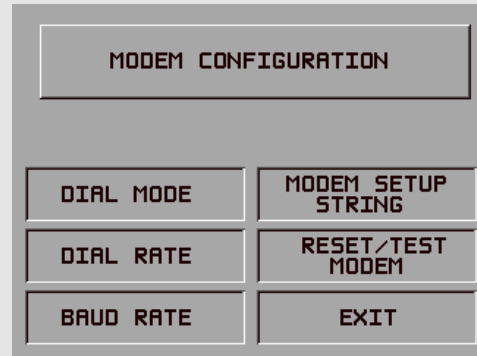

DESCRIPTION:

Selecting the **MODEM SETUP OPTION** from the **TELEPHONE** screen allows the terminal operator to select the following parameters:

- 1.) **DIAL MODE**
- 2.) **DIAL RATE**
- 3.) **BAUD RATE**
- 4.) **MODEM SETUP STRING**
- 5.) **RESET/TEST MODEM**

ERROR CONDITIONS:

There are no error conditions directly associated with this function.

SECTION 5 - MANAGEMENT FUNCTIONS

FUNCTION: DIAL MODE

FACTORY DEFAULT: 'DTMF'

ACCESS INSTRUCTIONS:

- 1.) Select **TERMINAL CONFIGURATION** from the **MANAGEMENT FUNCTIONS** menu.
- 2.) Select **SET TERMINAL PARAMETERS**.
- 3.) Select **TELEPHONE**.
- 4.) Select the **MODEM SETUP** option.
- 5.) Select **DIAL MODE**.



The screenshot shows a terminal screen with the following layout: At the top, a box contains 'DIAL MODE'. Below it, 'DTMF' is displayed with a yellow underline. At the bottom, there are three buttons: 'DTMF (TOUCH-TONE)', 'PULSE (ROTARY)', and 'EXIT'.

DESCRIPTION:

The modem is configured to dial in either the touch-tone mode (DTMF), or in the rotary (PULSE) mode. Consult with the local phone company to determine which option is supported. After selecting the dial mode, be certain to execute the **RESET/TEST MODEM** function. The new dial mode does not take effect until you do this. The factory default for the function is DTMF.

ERROR CONDITIONS:

If the local phone exchange does not support touch-tone, and the terminal is configured for DTMF mode, no calls will be completed. Rotary will work on touch-tone systems, but should not be used if touch-tone is available. Rotary mode will dial much slower than DTMF.

SECTION 5 - MANAGEMENT FUNCTIONS

FUNCTION: DIAL RATE

FACTORY DEFAULT: 'FAST'

ACCESS INSTRUCTIONS:

- 1.) Select **TERMINAL CONFIGURATION** from the **MANAGEMENT FUNCTIONS** menu.
- 2.) Select **SET TERMINAL PARAMETERS**.
- 3.) Select **TELEPHONE**.
- 4.) Select the **MODEM SETUP** option.
- 5.) Select **DIAL RATE**.



DESCRIPTION:

The internal modem can be configured to send dial tones at one of three speeds. The possible values are **FAST** (75 milliseconds), **MED.** (150 ms), and **SLOW** (255 ms). The default value from the factory is **FAST**. After changing the dial rate, be certain to execute the **RESET/TEST MODEM** function. The new dial rate does not take effect until you do this.

ERROR CONDITIONS:

There are no error conditions directly associated with this function, but if calls seem to fail, try a slower setting.

SECTION 5 - MANAGEMENT FUNCTIONS

FUNCTION: BAUD RATE

FACTORY DEFAULT: '1200'

ACCESS INSTRUCTIONS:

- 1.) Select **TERMINAL CONFIGURATION** from the **MANAGEMENT FUNCTIONS** menu.
- 2.) Select **SET TERMINAL PARAMETERS**.
- 3.) Select **TELEPHONE**.
- 4.) Select the **MODEM SETUP** option.
- 5.) Select **BAUD RATE**.

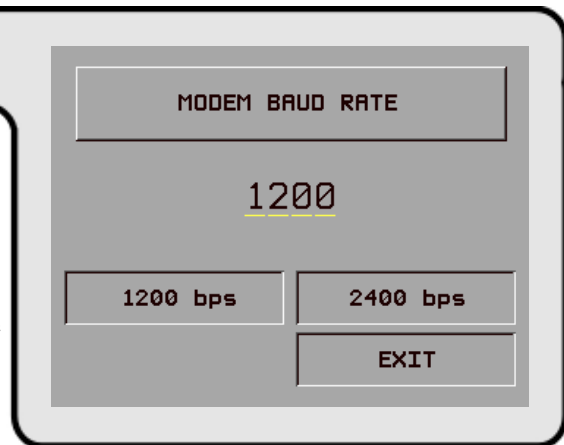

DESCRIPTION:

The bit rate of the modem can be controlled with this function. The rate can be set to 2400 or 1200 bits per second (bps). The default rate depends on your processor. Do not select 2400 if your processor does not support it.

ERROR CONDITIONS:

If the speed of the modem is set to 2400 bps, it may not connect to a 1200 bps system. The baud rate of the modem should always be set to the value indicated by your processor.

SECTION 5 - MANAGEMENT FUNCTIONS

FUNCTION: MODEM SETUP STRING

FACTORY DEFAULT: MODEM-SPECIFIC

ACCESS INSTRUCTIONS:

- 1.) Select **TERMINAL CONFIGURATION** from the **MANAGEMENT FUNCTIONS** menu.
- 2.) Select **SET TERMINAL PARAMETERS**.
- 3.) Select **TELEPHONE**.
- 4.) Select the **MODEM SETUP** option.
- 5.) Select **MODEM SETUP STRING**.

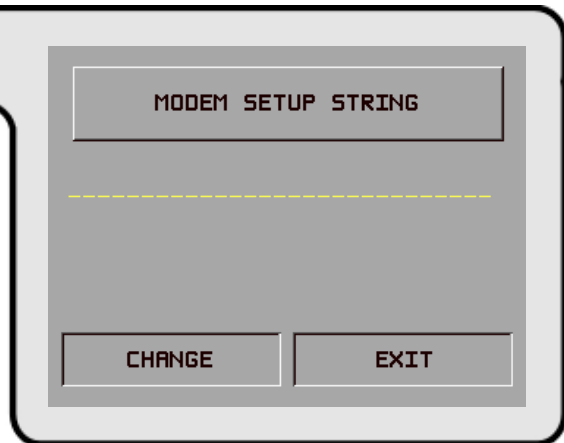

DESCRIPTION:

If special circumstances require a nonstandard modem configuration, a Hayes-compatible setup string can be sent to the modem when it is initialized.

ERROR CONDITIONS:

Setting this value incorrectly will cause communication failure due to improper modem setup. **Consult Triton's Technical Service Department before changing this parameter.**

SECTION 5 - MANAGEMENT FUNCTIONS

FUNCTION: RESET/TEST MODEM

FACTORY DEFAULT: N/A

ACCESS INSTRUCTIONS:

- 1.) Select **TERMINAL CONFIGURATION** from the **MANAGEMENT FUNCTIONS** menu.
- 2.) Select **SET TERMINAL PARAMETERS**.
- 3.) Select **TELEPHONE**.
- 4.) Select the **MODEM SETUP** option.
- 5.) Select **RESET/TEST MODEM**.

DESCRIPTION:

This function is used to reset and test the internal modem. It should be run after setting any of the modem configuration parameters to make sure an error was not made. It **MUST** be run after changing the **DIAL MODE** or **DIAL RATE**, otherwise these new values will not take effect until the unit is turned off and back on again.

At the conclusion of the test a screen will appear indicating that the **MODEM CONFIGURED AND TESTED OK**.

ERROR CONDITIONS:

An error message will indicate a problem if the setup string is invalid or the modem is not responding.

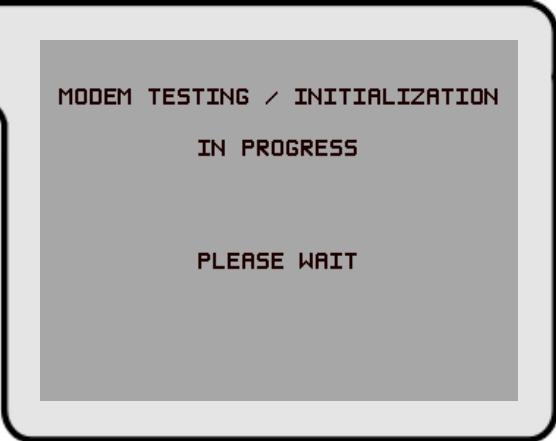

MODEM TESTING / INITIALIZATION
IN PROGRESS
PLEASE WAIT

SECTION 5 - MANAGEMENT FUNCTIONS

FUNCTION: MORE (TERMINAL PARAMETERS)

FACTORY DEFAULT: N/A

ACCESS INSTRUCTIONS:

- 1.) Select TERMINAL CONFIGURATION from the MANAGEMENT FUNCTIONS menu.
- 2.) Select SET TERMINAL PARAMETERS.
- 3.) Choose MORE.

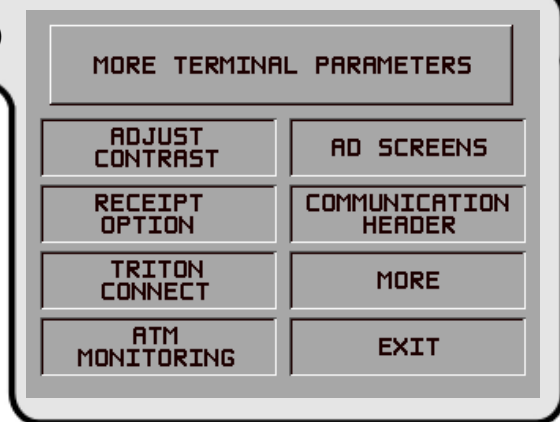

DESCRIPTION:

Selecting the MORE TERMINAL PARAMETERS option from the TERMINAL PARAMETERS allows the terminal operator or a service technician to view or change the following:

- 1.) ADJUST CONTRAST
- 2.) RECEIPT OPTION
- 3.) TRITON CONNECT
- 4.) ATM MONITORING
- 5.) AD SCREENS
- 6.) COMMUNICATION HEADER
- 7.) MORE

ERROR CONDITIONS:

There are no error conditions directly associated with this function.

SECTION 5 - MANAGEMENT FUNCTIONS

FUNCTION: ADJUST CONTRAST

FACTORY DEFAULT: CONTRAST: Mid-Range

ACCESS INSTRUCTIONS:

- 1.) Select **TERMINAL CONFIGURATION** from the **MANAGEMENT FUNCTIONS** menu.
- 2.) Select **SET TERMINAL PARAMETERS**.
- 3.) Choose **MORE**.
- 4.) Choose **ADJUST CONTRAST**.



DESCRIPTION:

This feature allows the terminal operator to adjust the contrast of the display.

Change the contrast of the display by selecting the designated **UP** or **DOWN** key to set the display contrast for best viewing.

ERROR CONDITIONS:

There are no error conditions directly associated with this function.

SECTION 5 - MANAGEMENT FUNCTIONS

FUNCTION: RECEIPT OPTION

FACTORY DEFAULT: DISABLED

ACCESS INSTRUCTIONS:

- 1.) Select **TERMINAL CONFIGURATION** from the **MANAGEMENT FUNCTIONS** menu.
- 2.) Select **SET TERMINAL PARAMETERS**.
- 3.) Choose **MORE**.
- 4.) Choose **RECEIPT OPTION**.



DESCRIPTION:

This feature allows the customer to select the option of receiving or not receiving a receipt at the completion of a transaction. When **RECEIPT OPTION** is **ENABLED** the customer is presented with a message at the conclusion of the transaction asking whether they want a receipt or not. If they respond **NO** to the question, a receipt is not dispensed. If they respond **YES** to the question a receipt is printed. If the customer does not respond to the question, a receipt is automatically printed after a forty-second delay.

If you don't want the customer to have this option, **DISABLE** the **RECEIPT OPTION**. Customers will then receive a receipt after every transaction.

ERROR CONDITIONS:

There are no error conditions directly associated with this function.

SECTION 5 - MANAGEMENT FUNCTIONS

FUNCTION: TRITON CONNECT

FACTORY DEFAULT: DISABLED

ACCESS INSTRUCTIONS:

- 1.) Select TERMINAL CONFIGURATION from the MANAGEMENT FUNCTIONS menu.
- 2.) Select SET TERMINAL PARAMETERS.
- 3.) Choose MORE.
- 4.) Choose TRITON CONNECT.



DESCRIPTION:

Selecting the TRITON CONNECT function allows the terminal operator to set up the following parameters associated with Triton Connect:

- 1.) PRIMARY NUMBER
- 2.) BACKUP NUMBER
- 3.) ALARM NUMBERS
- 4.) CALL BACK (ENABLE\DISABLE)
- 5.) TRITON CONNECT (ENABLE\DISABLE)

NOTE: Triton Connect is an option and may not be installed on your terminal.

ERROR CONDITIONS:

There are no error conditions directly associated with this function.

SECTION 5 - MANAGEMENT FUNCTIONS

FUNCTION: PRIMARY NUMBER

FACTORY DEFAULT: NONE

ACCESS INSTRUCTIONS:

- 1.) Select **TERMINAL CONFIGURATION** from the **MANAGEMENT FUNCTIONS** menu.
- 2.) Select **SET TERMINAL PARAMETERS**.
- 3.) Choose **MORE**.
- 4.) Select **TRITON CONNECT**.
- 5.) Choose **PRIMARY NUMBER**.

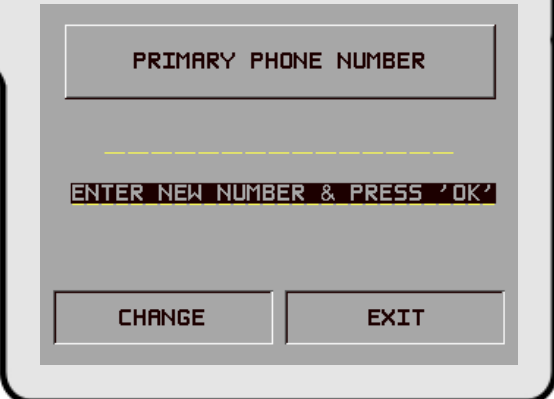

PRIMARY PHONE NUMBER

ENTER NEW NUMBER & PRESS 'OK'

CHANGE EXIT

DESCRIPTION:

The **PRIMARY NUMBER** function is used to enter the number that the terminal can use for calling back the Triton Connect Host Computer.

When this function is selected, the current phone number is displayed (if nothing appears on the screen, no number is set). Select **CHANGE** to blank the current entry, and then enter the desired phone number. The phone number may be up to 30 digits long. It can also contain a dialing prefix, such as a '9' for an outside line, if necessary. If you need to pause after the prefix, place a comma in the number for a two-second delay at that point. Pressing the **<BLUE>** key first, then the **<0>** key, followed by the **<RIGHT ARROW>** key to select the comma character. Make sure to enter the long distance prefix '1' if you are dialing an 800 number or a toll long distance number. Do not enter dashes in the number.

ERROR CONDITIONS::

There are no error conditions directly associated with this function.

SECTION 5 - MANAGEMENT FUNCTIONS

FUNCTION: BACKUP NUMBER

FACTORY DEFAULT: NONE

ACCESS INSTRUCTIONS:

- 1.) Select TERMINAL CONFIGURATION from the MANAGEMENT FUNCTIONS menu.
- 2.) Select SET TERMINAL PARAMETERS.
- 3.) Choose MORE.
- 4.) Select TRITON CONNECT.
- 5.) Choose BACKUP NUMBER.

The screenshot shows a terminal interface for setting a backup telephone number. At the top, it says 'BACKUP TELEPHONE NUMBER'. Below that is a dashed line and a prompt 'ENTER NEW NUMBER & PRESS 'OK''. At the bottom, there are two buttons: 'CHANGE' and 'EXIT'.

DESCRIPTION:

The BACKUP NUMBER function is used to enter a backup number that the terminal can use for calling back the Triton Connect computer.

When this function is selected, the current phone number is displayed (if nothing appears on the screen, no number is set). Select CHANGE to blank the current entry, and then enter the desired phone number. The phone number may be up to 30 digits long. It can also contain a dialing prefix, such as a '9' for an outside line, if necessary. If you need to pause after the prefix, place a comma in the number for a two-second delay at that point. Press the <BLUE> key, then the <0> key, followed by the <RIGHT ARROW> key to select the comma character. Make sure to enter the long distance prefix '1' if you are dialing an 800 number or a toll long distance number. Do not enter dashes in the number.

ERROR CONDITIONS:

There are no error conditions directly associated with this function.

SECTION 5 - MANAGEMENT FUNCTIONS

FUNCTION: ALARM NUMBERS

FACTORY DEFAULT: N/A

ACCESS INSTRUCTIONS:

- 1.) Select **TERMINAL CONFIGURATION** from the **MANAGEMENT FUNCTIONS** menu.
- 2.) Select **SET TERMINAL PARAMETERS**.
- 3.) Choose **MORE**.
- 4.) Choose **TRITON CONNECT**.
- 5.) Choose **ALARM NUMBERS**.

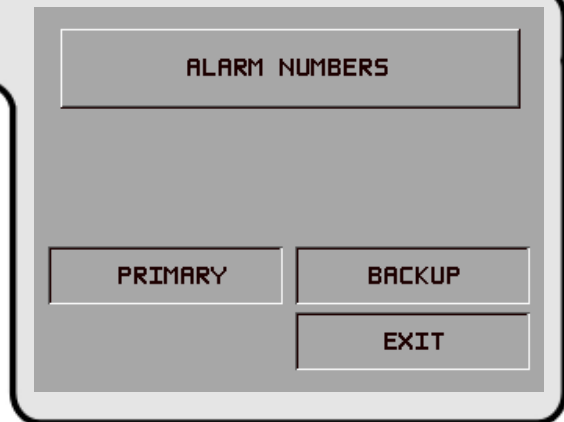

DESCRIPTION:

In some applications the terminal monitoring organization may require different telephone numbers for alarm reporting purposes. This could enable a third party service organization, for example, to be notified of alarm conditions that can occur during non-business hours. Selecting the **ALARM NUMBERS** option brings up a menu that allows the terminal operator to select and configure the Primary and Backup Triton Connect Alarm Numbers.

NOTE: Triton Connect is an option and may not be installed on your terminal.

ERROR CONDITIONS:

There are no error conditions directly associated with this function.

SECTION 5 - MANAGEMENT FUNCTIONS

FUNCTION: PRIMARY ALARM NUMBER

FACTORY DEFAULT: NONE

ACCESS INSTRUCTIONS:

- 1.) Select TERMINAL CONFIGURATION from the MANAGEMENT FUNCTIONS menu.
- 2.) Select SET TERMINAL PARAMETERS.
- 3.) Choose MORE.
- 4.) Select TRITON CONNECT.
- 5.) Select ALARM NUMBERS.
- 6.) Choose PRIMARY.

DESCRIPTION:

The PRIMARY ALARM NUMBER function is used to enter the telephone number that the terminal can use for calling back the Triton Connect Host Computer.

When this function is selected, the current phone number is displayed (if nothing appears on the screen, no number is set). Select CHANGE to blank the current entry, and then enter the desired phone number. The phone number may be up to 30 digits long. It can also contain a dialing prefix, such as a '9' for an outside line, if necessary. If you need to pause after the prefix, place a comma in the number for a two-second delay at that point. Pressing the <BLUE> key first, then the <0> key, followed by the <RIGHT ARROW> key to select the comma character. Make sure to enter the long distance prefix '1' if you are dialing an 800 number or a toll long distance number. Do not enter dashes in the number.

ERROR CONDITIONS::

There are no error conditions directly associated with this function.

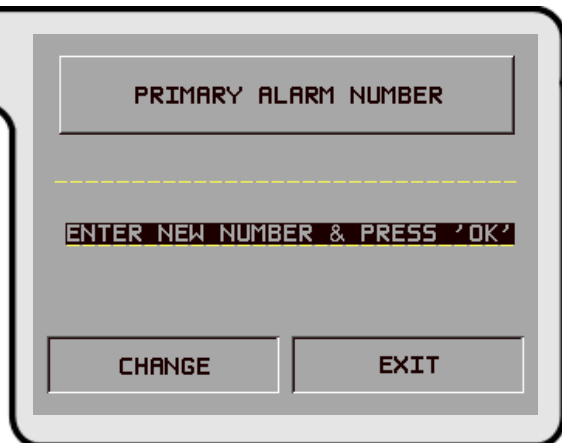

SECTION 5 - MANAGEMENT FUNCTIONS

FUNCTION: **BACKUP ALARM NUMBER**

FACTORY DEFAULT: NONE

ACCESS INSTRUCTIONS:

- 1.) Select **TERMINAL CONFIGURATION** from the **MANAGEMENT FUNCTIONS** menu.
- 2.) Select **SET TERMINAL PARAMETERS**.
- 3.) Choose **MORE**.
- 4.) Select **TRITON CONNECT**.
- 5.) Select **ALARM NUMBERS**.
- 6.) Choose **BACKUP**.

The screenshot shows a terminal interface with a grey background. At the top, a box contains the text "BACKUP ALARM NUMBER". Below this, a dashed yellow line separates the header from the main display area. The main display area shows the text "ENTER NEW NUMBER & PRESS 'OK'" in a dark box. At the bottom, there are two buttons: "CHANGE" on the left and "EXIT" on the right.

DESCRIPTION:

The **BACKUP ALARM NUMBER** function is used to enter a backup telephone number that the terminal can use for calling back the Triton Connect computer.

When this function is selected, the current phone number is displayed (if nothing appears on the screen, no number is set). Select **CHANGE** to blank the current entry, and then enter the desired phone number. The phone number may be up to 30 digits long. It can also contain a dialing prefix, such as a '9' for an outside line, if necessary. If you need to pause after the prefix, place a comma in the number for a two-second delay at that point. Press the <BLUE> key, then the <0> key, followed by the <RIGHT ARROW> key to select the comma character. Make sure to enter the long distance prefix '1' if you are dialing an 800 number or a toll long distance number. Do not enter dashes in the number.

ERROR CONDITIONS:

There are no error conditions directly associated with this function.

SECTION 5 - MANAGEMENT FUNCTIONS

FUNCTION: ENABLE/DISABLE CALL BACK

FACTORY DEFAULT: ENABLED

ACCESS INSTRUCTIONS:

- 1.) Select **TERMINAL CONFIGURATION** from the **MANAGEMENT FUNCTIONS** menu.
- 2.) Select **SET TERMINAL PARAMETERS**.
- 3.) Choose **MORE**.
- 4.) Select **TRITON CONNECT**.



DESCRIPTION:

Normally, when the Triton Connect Host Computer contacts a terminal, it will hang up and wait for the terminal to **CALL BACK**. This is done for security reasons. The **CALL BACK** option allows the terminal operator to enable and disable this feature.

Once you've reached the **TRITON CONNECT** screen, the **CALL BACK** button will present an option to reverse the current state of the feature. For example, if **CALL BACK** is currently **ENABLED**, the **CALL BACK** option button will show the **DISABLE CALL BACK** option. Conversely, if **CALL BACK** is currently **DISABLED**, the **CALL BACK** option button will show the **ENABLE CALL BACK** option.

ERROR CONDITIONS:

There are no error conditions directly associated with this function.

SECTION 5 - MANAGEMENT FUNCTIONS

FUNCTION: ENABLE/DISABLE TRITON CONNECT

FACTORY DEFAULT: DISABLED

ACCESS INSTRUCTIONS:

- 1.) Select **TERMINAL CONFIGURATION** from the **MANAGEMENT FUNCTIONS** menu.
- 2.) Select **SET TERMINAL PARAMETERS**.
- 3.) Choose **MORE**.
- 4.) Select **TRITON CONNECT**.

TRITON CONNECT
TRITON CONNECT IS DISABLED
CALL BACK IS ENABLED

PRIMARY NUMBER	DISABLE CALL BACK
BACKUP NUMBER	ENABLE TRITON CONNECT
ALARM NUMBERS	EXIT

DESCRIPTION:

If the Triton Connect feature has been **ACTIVATED** (using the **ACTIVATE** function), this function can be used to **ENABLE** or **DISABLE** Triton Connect access to the terminal.

Once you've reached the **TRITON CONNECT** screen, the **TRITON CONNECT** button will present an option to reverse the current state of this feature. For example, if Triton Connect is currently **ENABLED**, the button will show the **DISABLE TRITON CONNECT** option. Conversely, if Triton Connect is currently **DISABLED**, the option button will show the **ENABLE TRITON CONNECT** option.

ERROR CONDITIONS:

There are no error conditions directly associated with this function.

SECTION 5 - MANAGEMENT FUNCTIONS

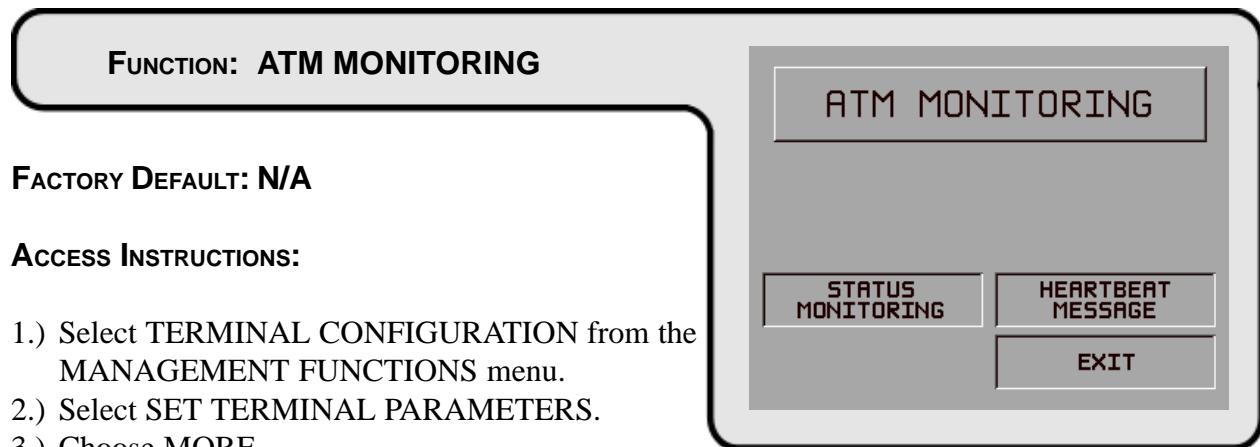

FUNCTION: ATM MONITORING

FACTORY DEFAULT: N/A

ACCESS INSTRUCTIONS:

- 1.) Select TERMINAL CONFIGURATION from the MANAGEMENT FUNCTIONS menu.
- 2.) Select SET TERMINAL PARAMETERS.
- 3.) Choose MORE.
- 4.) Select ATM MONITORING.

DESCRIPTION:

The ATM Monitoring screen provides access to the following functions:

- 1.) STATUS MONITORING. When this feature is enabled the terminal will send operational status information to the processor during the certain transactions.
- 2.) HEARTBEAT MESSAGE. The Heartbeat Message feature is designed to provide a means of reporting communications system status to the host processor. This feature is only available for those processors supporting terminals running Triton Standard operating software.

ERROR CONDITIONS:

There are no error conditions directly associated with this function.

SECTION 5 - MANAGEMENT FUNCTIONS

FUNCTION: STATUS MONITORING

FACTORY DEFAULT: DISABLED

ACCESS INSTRUCTIONS:

- 1.) Select **TERMINAL CONFIGURATION** from the **MANAGEMENT FUNCTIONS** menu.
- 2.) Select **SET TERMINAL PARAMETERS**.
- 3.) Choose **MORE**.
- 4.) Select **ATM MONITORING**.
- 5.) Select **STATUS MONITORING**.

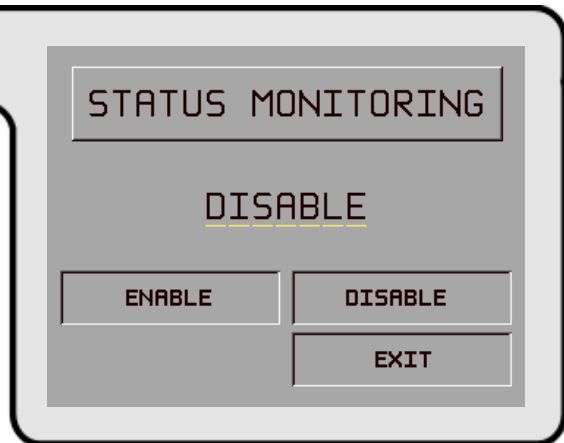

DESCRIPTION:

STATUS MONITORING is a feature that is available with selected processor software. When enabled the terminal will send operational status information to the processor during certain transactions with the processor. The status information is sent in a data field that is part of any of the following messages sent to the processor:

- 1.) A Transaction Request Message
- 2.) Configuration Table Download Request Message (Comms Key Download)
- 3.) Host Totals Download Request Message
- 4.) Reversal Request Message.

Turn this feature on by selecting the **ENABLE** option on this screen. Select **DISABLE** to inhibit the operation of the **STATUS MONITORING** feature.

ERROR CONDITIONS:

There are no error conditions directly associated with this function.

SECTION 5 - MANAGEMENT FUNCTIONS

FUNCTION: HEARTBEAT MESSAGE

FACTORY DEFAULT: DISABLED

ACCESS INSTRUCTIONS:

- 1.) Select **TERMINAL CONFIGURATION** from the **MANAGEMENT FUNCTIONS** menu.
- 2.) Select **SET TERMINAL PARAMETERS**.
- 3.) Choose **MORE**.
- 4.) Select **ATM MONITORING**.
- 5.) Select **HEARTBEAT MESSAGE**.

HEARTBEAT MESSAGE IS: ENABLED
AND
THE DELAY PERIOD IS: ___ MINUTES

ENABLE

CHANGE
DELAY PERIOD

DISABLE

EXIT

DESCRIPTION:

The **HEARTBEAT MESSAGE** feature is designed to provide a means of reporting communications system status to the host processor.

Status reporting by dial-up ATMs is now the norm, but the single most important feature that cannot be monitored is the communications status. The absence of transactions from a particular terminal can mean one of two things. Usually the lack of calls indicates nothing more than a slow period. Sometimes, though, a piece of the communications system will fail and inhibit any calls from being made. The host has no way of determining which scenario is occurring in any kind of real-time mode. The Heartbeat Message overcomes this limitation.

When this feature is **ENABLED**, the terminal will call the host after a period of inactivity. During this call, the terminal will request a **COMMS KEY DOWNLOAD** (the normal configuration download request), and will also report status (if the **STATUS MONITORING** function is **ENABLED**). This allows the host to determine if a particular terminal is still in operation, even though it may not be performing any transactions at the time. With this feature enabled, the host can finally monitor communications system failures.

The Heartbeat Message feature on the Cash Dispenser has several parameters that must be set to operate properly. These parameters are:

- 1.) **HEARTBEAT MESSAGE**. This parameter turns on or off the regular call to the host.
- 2.) **DELAY PERIOD**. This parameter sets the time interval that must expire before a Heartbeat Message will be sent. It is specified in minutes.

SECTION 5 - MANAGEMENT FUNCTIONS

Once the Heartbeat Message call feature is enabled at the terminal, an internal timer will be initialized to the number of minutes set in the DELAY PERIOD parameter at system power-up and after a reset. This timer is restarted each time a call is made to the host. A call to the host is defined as any transaction, including financial, balancing and configuration that actually communicates with the host to the point that the Terminal ID is recognized. A customer transaction that is declined will reset the timer, while a call that fails because the host phone number was busy would not.

It is important to remember that as long as transactions are being done on the terminal on a regular basis, Heartbeat Message calls will not be made. The sole purpose of these calls is to let the host know that the terminal is OK when it is NOT performing regular transactions.

Because the primary purpose of the Heartbeat Message call is to let the host know everything is all right, a Heartbeat Message call that DOES NOT succeed for any reason is not retried. If the call does fail, the interval timer will be reset and the terminal will remain in service.

While the concept of the Heartbeat Message call is simple, interpreting the absence of an expected call must be explained. Listed below are reasons why Heartbeat Message calls will not be received at the host either when expected or at all.

Feature Not Turned On

Obviously, if the feature is not enabled, no Heartbeat Message calls will be made.

Terminal is Doing Transactions

If the terminal does at least one regular customer transaction or balancing transaction before the interval timer, no Heartbeat Message call will be made.

Terminal is in Management Function Mode

Heartbeat Message calls are suspended while the terminal is in the Management mode, although the interval timer continues to run. If the timer expires while the terminal is in this mode, the call will be delayed until the terminal returns to the normal service mode.

Terminal is Out of Service

When the terminal goes out of service, one Heartbeat Message call is made. After that call, all further calls are suspended until it is returned to normal service.

SECTION 5 - MANAGEMENT FUNCTIONS

Terminal is Turned Off or Power Has Failed

If the terminal is turned off, no calls will be made. While an obvious point, it means that for this feature to be of any value, the terminal must always remain on.

Communications System Has Failed

A failure of any piece of the communications system will result in missed calls. This includes the terminal modem, the phone line to the terminal, and any intermediate telecommunications providers.

Terminal Was Reset or Power Cycled

Since the interval timer is reset when the terminal is reset, a scheduled call may not occur at the expected time.

To realize the benefits of the Heartbeat Message, the host must be programmed to monitor the interval between calls from the terminal. It is important to note, though, that the host interval threshold should be set to a value greater than that programmed at the terminal. A practical guideline is at least twice the terminal interval. This allows for Heartbeat Message calls that are delayed because the terminal is in Management mode, or calls skipped because of a system reset.

ERROR CONDITIONS:

There are no error conditions directly associated with this function.

SECTION 5 - MANAGEMENT FUNCTIONS

FUNCTION: AD SCREENS

FACTORY DEFAULT: ENABLED

ACCESS INSTRUCTIONS:

- 1.) Select TERMINAL CONFIGURATION from the MANAGEMENT FUNCTIONS menu.
- 2.) Select SET TERMINAL PARAMETERS.
- 3.) Choose MORE.
- 4.) Select AD SCREENS.

AD SCREENS

ENABLE

ENABLE

DISABLE

EXIT

DESCRIPTION:

The AD SCREENS function causes the display on an idle terminal to alternate between the WELCOME SCREEN and a screen containing graphics and text elements. These graphics and text elements form an advertisement (“Ad”) Screen. Ad Screens are created in a special graphics editor that is part of the Triton Connect[™] software program. The graphics editor lets the user import color bit-mapped graphic files in the ‘.bmp’ format, with a maximum resolution of 320 dots by 240 dots. Each graphic can be moved within the display area, allowing room for text that can also be added to the display.

The graphic and any associated text are saved in the proprietary ‘.TCG’ (Triton Connect Graphic) file format. Triton Connect is then used to download the TCG file to the terminals’ Graphics Memory, for subsequent presentation on the LCD screen. Multiple Ad Screens may be downloaded, if desired, for display in a user-defined sequence. In addition to the Ad Screen file, data is also downloaded that establishes what time of day and for how long the the Ad Screen should be displayed.

Selecting ENABLE from the AD SCREENS Menu turns on the AD SCREENS feature. Selecting DISABLE turns off the feature.

ERROR CONDITIONS:

There are no error conditions directly associated with this function.

SECTION 5 - MANAGEMENT FUNCTIONS

FUNCTION: COMMUNICATION HEADER

FACTORY DEFAULT: PROCESSOR-SPECIFIC

ACCESS INSTRUCTIONS:

- 1.) Select **TERMINAL CONFIGURATION** from the **MANAGEMENT FUNCTIONS** menu.
- 2.) Select **SET TERMINAL PARAMETERS**.
- 3.) Choose **MORE**.
- 3.) Select **COMMUNICATION HEADER**.



DESCRIPTION:

The **COMMUNICATION HEADER** is an optional feature that is only applicable to certain processors. When a specified processor requires the use of the **COMMUNICATIONS HEADER** it must be **ENABLED** and have the correct data in the header data field. The **COMMUNICATION HEADER** data field consists of alphanumeric characters.

To enter a digit 0-9, press the key that has that digit. To enter a letter, first press the **<BLUE>** key, then press the key that has the letter you want on it. The first press of the key will display the first character above the number. Subsequent presses will display the characters in sequence. When the character you want is displayed, press the **<RIGHT ARROW>** key to 'lock in' the character. If your next character is a letter, you must press the **<BLUE>** key again.

ERROR CONDITIONS:

Enabling the **COMMUNICATION HEADER** when using a processor that doesn't use this feature will prevent any type of transaction from completing. Disabling or having incorrect data in the **COMMUNICATION HEADER** data field (if the feature is required) will also prevent any type of transaction from processing.

SECTION 5 - MANAGEMENT FUNCTIONS

FUNCTION: MORE (TERMINAL PARAMETERS)

FACTORY DEFAULT: N/A

ACCESS INSTRUCTIONS:

- 1.) Select **TERMINAL CONFIGURATION** from the **MANAGEMENT FUNCTIONS** menu.
- 2.) Select **SET TERMINAL PARAMETERS**.
- 3.) Choose **MORE**.
- 4.) Select **MORE**.



DESCRIPTION:

This screen allows you to select additional terminal parameters functions. The functions available are **ALARM THRESHOLDS** and **VIEW/MODIFY OPTIONS**. **ALARM THRESHOLDS** is used to monitor the status of various parameters (such as number of journal entries, or the level of cash remaining in the cassette), and determines at what point a notification message will be sent to a remote computer. This remote computer must be running Triton Connect monitoring software.

The **VIEW/MODIFY OPTIONS** function is used to activate or deactivate special terminal features such as Triton Connect.

ERROR CONDITIONS:

There are no error conditions directly associated with this function.

SECTION 5 - MANAGEMENT FUNCTIONS

FUNCTION: ALARM THRESHOLDS

FACTORY DEFAULT: OFF

ACCESS INSTRUCTIONS:

- 1.) Select **TERMINAL CONFIGURATION** from the **MANAGEMENT FUNCTIONS** menu.
- 2.) Select **SET TERMINAL PARAMETERS**.
- 3.) Choose **MORE**.
- 4.) Select **MORE**.
- 5.) Select **ALARM THRESHOLDS**.

CASH THRESHOLD =		----
JOURNAL THRESHOLD =		----
JOURNAL SCHEDULE =		:00
LOW CASH THRESHOLD	OFF	SET LOW CASH THRESHOLD
JOURNAL THRESHOLD	OFF	SET JOURNAL THRESHOLD
SCHEDULED JOURNAL	OFF	SET SCHEDULED JOURNAL
EXIT		

DESCRIPTION:

This function allows you to turn on or off the **LOW CASH THRESHOLD**, **JOURNAL THRESHOLD**, and **SCHEDULED JOURNAL** features.

- 1.) **LOW CASH THRESHOLD**. When this feature is turned ON, the terminal sends a notification message to a remote Triton Connect computer if the amount of cash in the cassette falls below the level specified using the **SET LOW CASH THRESHOLD** function. When this feature is turned OFF, no notification message will be sent.
- 2.) **JOURNAL THRESHOLD**. When this feature is turned ON, the terminal will send a notification message to a remote Triton Connect computer if the number of entries in the journal exceeds the level specified using the **SET JOURNAL THRESHOLD** function. When this feature is turned OFF, no notification message will be sent.
- 3.) **SCHEDULED JOURNAL**. When this feature is turned ON, the terminal will automatically send all journal data to a remote Triton Connect computer at a time established using the **SET SCHEDULED JOURNAL** function. When this feature is turned OFF, the journal will not be sent automatically.

The current state of each function is shown as either **ON** or **OFF** in the applicable label on the left-hand side of the display. Press the button next to the applicable label to toggle the state of the feature between **ON** and **OFF**.

ERROR CONDITIONS:

There are no error conditions directly associated with this function.

SECTION 5 - MANAGEMENT FUNCTIONS

FUNCTION: SET LOW CASH THRESHOLD

FACTORY DEFAULT: 0

ACCESS INSTRUCTIONS:

- 1.) Select **TERMINAL CONFIGURATION** from the **MANAGEMENT FUNCTIONS** menu.
- 2.) Select **SET TERMINAL PARAMETERS**.
- 3.) Choose **MORE**.
- 4.) Select **MORE**.
- 5.) Select **ALARM THRESHOLDS**.
- 6.) Select **SET LOW CASH THRESHOLD**.

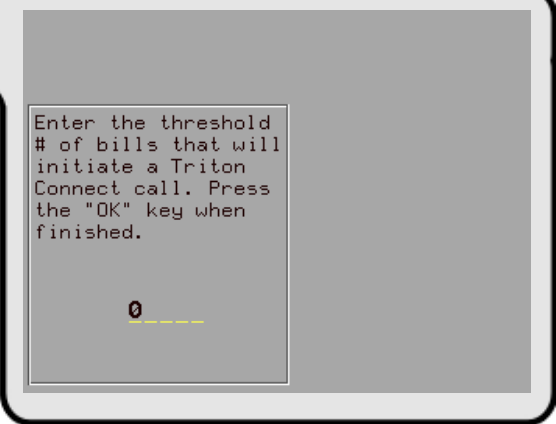

Enter the threshold
of bills that will
initiate a Triton
Connect call. Press
the "OK" key when
finished.

0

DESCRIPTION:

This function allows you to enter the number of bills that will act as a low cash threshold. When the number of bills in the cassette drops below the value set in this function, the terminal will automatically send a notification message to a remote Triton Connect computer.

To ensure the accuracy of the threshold, make sure to use the **ENTER QTY. IN CASSETTE** function after replenishing the cash in the cassette.

ERROR CONDITIONS:

There are no error conditions directly associated with this function.

SECTION 5 - MANAGEMENT FUNCTIONS

FUNCTION: SET JOURNAL THRESHOLD

FACTORY DEFAULT: 0

ACCESS INSTRUCTIONS:

- 1.) Select **TERMINAL CONFIGURATION** from the **MANAGEMENT FUNCTIONS** menu.
- 2.) Select **SET TERMINAL PARAMETERS**.
- 3.) Choose **MORE**.
- 4.) Select **MORE**.
- 5.) Select **ALARM THRESHOLDS**.
- 6.) Select **SET JOURNAL THRESHOLD**.

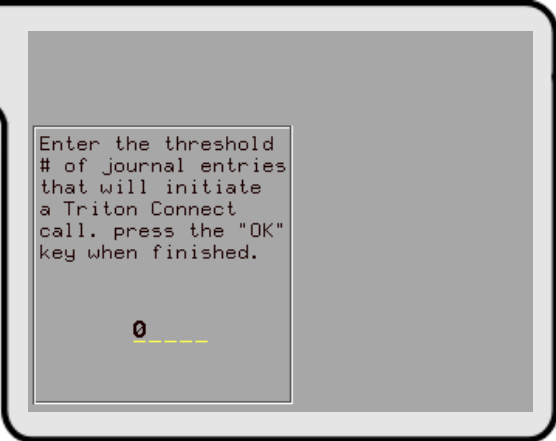

Enter the threshold
of journal entries
that will initiate
a Triton Connect
call. press the "OK"
key when finished.

0

DESCRIPTION:

This function allows you to enter the number of journal entries that will act as a threshold. When the number of journal entries rises above the value set in this function, and the Journal Threshold feature is **ENABLED**, the terminal will automatically contact the remote Triton Connect computer and initiate a transfer of the journal.

ERROR CONDITIONS:

IMPORTANT! If the threshold value is set to '0' (zero) while the Journal Threshold feature is **ENABLED**, no journal will be transmitted!

SECTION 5 - MANAGEMENT FUNCTIONS

FUNCTION: SET SCHEDULED JOURNAL

FACTORY DEFAULT: 0

ACCESS INSTRUCTIONS:

- 1.) Select **TERMINAL CONFIGURATION** from the **MANAGEMENT FUNCTIONS** menu.
- 2.) Select **SET TERMINAL PARAMETERS**.
- 3.) Choose **MORE**.
- 4.) Select **MORE**.
- 5.) Select **ALARM THRESHOLDS**.
- 6.) Select **SET SCHEDULED JOURNAL**.

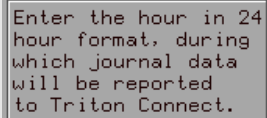

Enter the hour in 24
hour format, during
which journal data
will be reported
to Triton Connect.



__ :00

DESCRIPTION:

This function allows you to enter the time at which the terminal will automatically contact a remote Triton Connect computer and initiate a transfer of the journal.

ERROR CONDITIONS:

There are no error conditions directly associated with this function.

SECTION 5 - MANAGEMENT FUNCTIONS

FUNCTION: VIEW/MODIFY OPTIONS

FACTORY DEFAULT: N/A

ACCESS INSTRUCTIONS:

- 1.) Select TERMINAL CONFIGURATION from the MANAGEMENT FUNCTIONS menu.
- 2.) Select SET TERMINAL PARAMETERS.
- 3.) Choose MORE.
- 4.) Select MORE.
- 5.) Select VIEW/MODIFY OPTIONS.



DESCRIPTION:

The VIEW/MODIFY OPTIONS FUNCTION provides access to terminal parameters for setting the following:

- 1.) ACTIVATE (A selected feature.)
- 2.) DEACTIVATE (A selected feature.)
- 3.) SELECT FEATURE NUMBER

ERROR CONDITIONS:

There are no error conditions directly associated with this function.

SECTION 5 - MANAGEMENT FUNCTIONS

FUNCTION: ACTIVATE

FACTORY DEFAULT: N/A

ACCESS INSTRUCTIONS:

- 1.) Select **TERMINAL CONFIGURATION** from the **MANAGEMENT FUNCTIONS** menu.
- 2.) Select **SET TERMINAL PARAMETERS**.
- 3.) Choose **MORE**.
- 4.) Select **MORE**.
- 5.) Select **VIEW/MODIFY OPTIONS**.
- 6.) Choose **ACTIVATE**.



DESCRIPTION:

To activate a **FEATURE** an activation code must be obtained from the Triton Systems, Inc., Technical Support Department. When calling Triton Systems Inc., you will be asked to provide the serial number that is displayed on the **FEATURE 00 SERIAL NUMBER** screen.

Once the activation code is obtained, select the **ACTIVATE** option from the **FEATURE 00** Menu to display the **FEATURES 00 SERIAL NUMBER** screen. Enter the activation code into the terminal while the **FEATURE 00 SERIAL NUMBER** screen is displayed. Press **<OK>**. If the activation code is correct, a screen informing you that the terminal must be reset to activate the feature is displayed. Reset the terminal by depressing the **RESET** switch on the card cage or cycling the Main Power Switch on the Power Supply from **ON** to **OFF** to **ON**.

If the activation code is entered incorrectly, the terminal will beep 4 times and return to the **FEATURE 00** Menu.

ERROR CONDITIONS:

There are no error conditions directly associated with this function.

SECTION 5 - MANAGEMENT FUNCTIONS

FUNCTION: DEACTIVATE

FACTORY DEFAULT: N/A

ACCESS INSTRUCTIONS:

- 1.) Select **TERMINAL CONFIGURATION** from the **MANAGEMENT FUNCTIONS** menu.
- 2.) Select **SET TERMINAL PARAMETERS**.
- 3.) Choose **MORE**.
- 4.) Select **MORE**.
- 5.) Select **VIEW/MODIFY OPTIONS**.
- 6.) Choose **DEACTIVATE**.

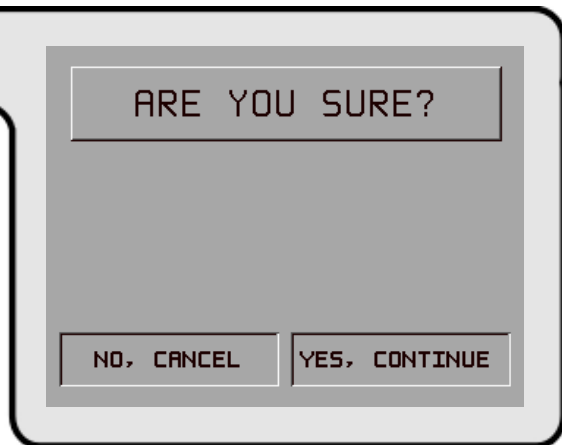

DESCRIPTION:

To **DEACTIVATE** a Feature (such as Feature 00 - Triton Connect), select the **DEACTIVATE** option from the **FEATURE** menu. When **DEACTIVATE** is selected a confirmation screen (“**ARE YOU SURE?**”) is displayed. Select **YES, CONTINUE** on the confirmation screen and the **FEATURE** Menu will be displayed indicating the Feature “**IS NOT ACTIVE**”.

Selecting the **NO, CANCEL** option when “**ARE YOU SURE?**” is displayed will return the display to the **FEATURE** main menu.

ERROR CONDITIONS:

There are no error conditions directly associated with this function.

SECTION 5 - MANAGEMENT FUNCTIONS

FUNCTION: SELECT FEATURE NUMBER

FACTORY DEFAULT: N/A

ACCESS INSTRUCTIONS:

- 1.) Select TERMINAL CONFIGURATION from the MANAGEMENT FUNCTIONS menu.
- 2.) Select SET TERMINAL PARAMETERS.
- 3.) Choose MORE.
- 4.) Select MORE.
- 5.) Select VIEW/MODIFY OPTIONS.
- 6.) Choose SELECT FEATURE NUMBER.

FEATURE 00
ENTER NUMBER, & PRESS 'OK'

ACTIVATE	SELECT FEATURE NUMBER
DEACTIVATE	EXIT

DESCRIPTION:

Selects the feature number to examine or to activate/deactivate. For example, entering the numbers “00” selects the Triton Connect feature. The current status of the feature will be displayed. Use the ACTIVATE and DEACTIVATE functions as appropriate to change the status of the selected feature.

ERROR CONDITIONS:

There are no error conditions directly associated with this function.

SECTION 5 - MANAGEMENT FUNCTIONS

FUNCTION: DATE / TIME FUNCTIONS

FACTORY DEFAULT: N/A

ACCESS INSTRUCTIONS:

- 1.) Select **TERMINAL CONFIGURATION** from the **MANAGEMENT FUNCTIONS** menu.
- 2.) Choose **DATE / TIME FUNCTIONS**.

DESCRIPTION:

This screen provides a menu of functions related to configuration of date and time parameters for the Cash Dispenser:

- 1.) **SET DATE FORMAT**. This option allows you to choose between a DD/MM/YY and a MM/DD/YY date format the terminal will use when printing receipts and other reports.
- 2.) **SET DATE / TIME**. This option enables you to configure the actual date and time the terminal uses when printing receipts and other reports.

ERROR CONDITIONS:

There are no error conditions directly associated with this function.

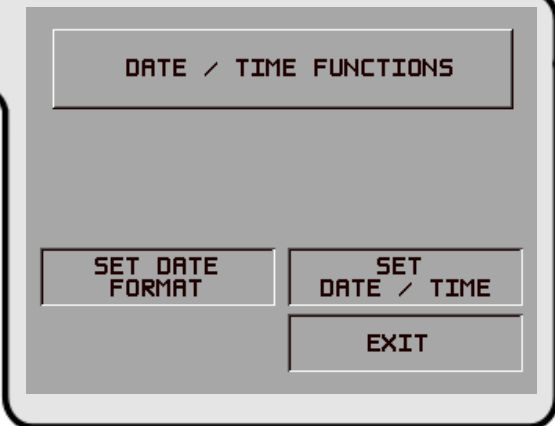

SECTION 5 - MANAGEMENT FUNCTIONS

FUNCTION: SET DATE FORMAT

FACTORY DEFAULT: MM/DD/YY

ACCESS INSTRUCTIONS:

- 1.) Select **TERMINAL CONFIGURATION** from the **MANAGEMENT FUNCTIONS** menu.
- 2.) Choose **DATE / TIME FUNCTIONS**.
- 3.) Choose **SET DATE FORMAT**.

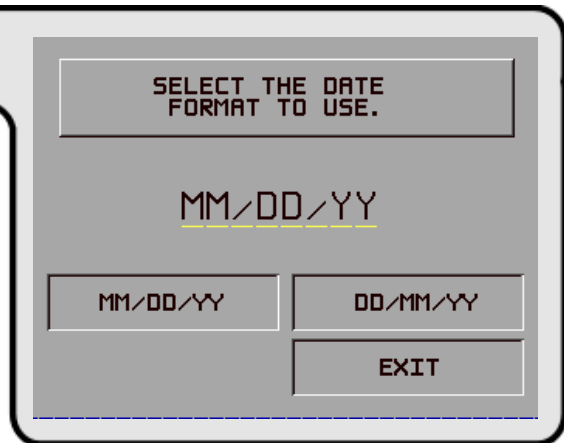

DESCRIPTION:

This function provides a way to change the date format the terminal uses when printing a date field on receipts and reports. Press the button next to the desired option to activate that format.

ERROR CONDITIONS:

There are no error conditions directly associated with this function.

SECTION 5 - MANAGEMENT FUNCTIONS

FUNCTION: SET DATE / TIME

FACTORY DEFAULT: N/A

ACCESS INSTRUCTIONS:

- 1.) Select **TERMINAL CONFIGURATION** from the **MANAGEMENT FUNCTIONS** menu.
- 2.) Choose **DATE/TIME FUNCTIONS**.
- 3.) Choose **SET DATE / TIME**

```

*DATE/TIME*

06/03/97      SET DATE-->
12:40:57 PM   SET TIME-->

                                EXIT- >
  
```

DESCRIPTION:

The Cash Dispenser contains an internal clock that maintains the date and time, even when power is disconnected from the unit.

Press **SET DATE** to begin the date entry process. Press **SET TIME** to begin the time entry process.

ERROR CONDITIONS:

There are no error conditions directly associated with this function.

SECTION 5 - MANAGEMENT FUNCTIONS

FUNCTION: SET DATE

FACTORY DEFAULT: N/A

ACCESS INSTRUCTIONS:

- 1.) Select **TERMINAL CONFIGURATION** from the **MANAGEMENT FUNCTIONS** menu.
- 2.) Choose **DATE/TIME FUNCTIONS**.
- 3.) Select **SET DATE / TIME**.
- 4.) Select **SET DATE**..

DATE SET

MM/DD/YY

BACKSPACE-->

CLEAR-->

QUIT-->

SET DATE-->

DESCRIPTION:

Press **SET DATE** to begin the date entry process. The date is entered in the form 'MM/DD/YY' (month, day, year). Do not enter the '/' characters separating the fields, just the fields themselves. Press **CLEAR** to erase everything and start over. Press the **BACKSPACE** key to back up and erase a single character. Press **QUIT** to escape without doing anything. Press **SET DATE** to load the entered date into the clock.

The Cash Dispenser will not let you enter an invalid number for hours or minutes. The clock will properly handle the rollover to the year 2000.

ERROR CONDITIONS:

There are no error conditions directly associated with this function.

SECTION 5 - MANAGEMENT FUNCTIONS

FUNCTION: SET TIME

FACTORY DEFAULT: N/A

ACCESS INSTRUCTIONS:

- 1.) Select TERMINAL CONFIGURATION from the MANAGEMENT FUNCTIONS menu.
- 2.) Choose DATE/TIME FUNCTIONS.
- 3.) Select SET DATE / TIME.
- 4.) Select SET TIME...

TIME SET

```

                                BACKSPACE-->
HH:MM:SS XM                    CLEAR-->
                                QUIT-->
                                SET TIME-->

```

DESCRIPTION:

The time is entered in the form 'HH:MM:SS' (hours, minutes, seconds). Do not enter the ':' characters separating the fields, just the fields themselves. Press CLEAR to erase everything and start over. Press the BACKSPACE key to back up and erase a single character. Press QUIT to escape without doing anything. Press SET TIME to load the entered time into the clock.

The Cash Dispenser will not let you enter an invalid number for hours or minutes. The clock will properly handle the rollover to the year 2000.

ERROR CONDITIONS:

There are no error conditions directly associated with this function.

SECTION 5 - MANAGEMENT FUNCTIONS

FUNCTION: TRANSACTION TYPES

FACTORY DEFAULT: ON

ACCESS INSTRUCTIONS:

- 1.) Select the **TERMINAL CONFIGURATION** option from the **MANAGEMENT FUNCTIONS** screen.
- 2.) Select **TRANSACTION TYPES**.

PRESS THE BUTTON NEXT TO THE TRANSACTION TYPE TO TOGGLE IT ON OR OFF.

TRANSFERS OFF

BALANCE INQUIRIES OFF

EXIT

DESCRIPTION:

This function allows you to turn on or off the availability of the two transaction types: **TRANSFERS** and **BALANCE INQUIRIES**. When a transaction type is turned **ON**, the terminal will provide that option to the customer. When a transaction type is turned **OFF**, the selected transaction type will not be displayed to the customer.

The current state of the transaction type is shown as either **ON** or **OFF** in the applicable button label on the display. Press the button next to the label to toggle the state of the transaction type between **ON** and **OFF**.

ERROR CONDITIONS:

There are no error conditions directly associated with this function.

SECTION 5 - MANAGEMENT FUNCTIONS

FUNCTION: ACCOUNT TYPES

FACTORY DEFAULT: ON

ACCESS INSTRUCTIONS:

- 1.) Select the **TERMINAL CONFIGURATION** option from the **MANAGEMENT FUNCTIONS** screen.
- 2.) Select **ACCOUNT TYPES**.

PRESS THE BUTTON NEXT TO THE ACCOUNT TYPE TO TOGGLE IT ON OR OFF.

SAVINGS

OFF

CREDIT
CARD

ON

EXIT

DESCRIPTION:

This function allows you to turn on or off the availability of two account types: **SAVINGS** and **CREDIT CARD**. When an account type is turned **ON**, the terminal will provide that option to the customer. When an account type is turned **OFF**, the selected account type will not be displayed to the customer.

The current state of the account type is shown as either **ON** or **OFF** in the applicable button label on the display. Press the button next to the label to toggle the state of the account type between **ON** and **OFF**.

ERROR CONDITIONS:

There are no error conditions directly associated with this function.

SECTION 6
MAINTENANCE

SECTION 6 - MAINTENANCE

*** WARNING ***

No attempt should be made by the user to repair or service the unit! Any such attempt may damage the unit and will void the warranty.

CLEANING THE ENCLOSURE

The Mako Dispenser front panel is highly durable, resisting scratches and finger smudges. However, occasional cleaning of the front panel and the plastic enclosure may be desirable. A soft dry or slightly damp cloth may be used for cleaning. For best results, a weak solution of a mild detergent and water should be used.

WARNING

Avoid using abrasive cleaners on any surface of the Terminal. Do not spray cleaner liquids directly on the unit. .

CLEANING THE DISPLAY

The Liquid Crystal Display (LCD) on the front of the Dispenser has a plastic protective window that should be cleaned only with a SOFT cloth, dampened with a weak solution of a mild detergent and water.

WARNING

Do not use any abrasive cleaners on the window, as it will scratch. Do not spray liquids onto the screen, as they may run down inside the unit and cause damage.

CARD READER MAINTENANCE

Special cleaning cards are available for proper maintenance of the card reader. The reader should be cleaned at least once a month by inserting and removing a cleaning card, as shown in Figure 6-1. It may be necessary to clean the card reader more often in locations that see heavy usage.



Figure 6-1. Use the cleaning cards on a monthly basis to maintain effective card reader operation.

SECTION 6 - MAINTENANCE

REPLENISHING THE RECEIPT PAPER

NOTE:

This operation can be completed with the AC Power applied to the Terminal

1. This operation can be completed with the power on. Open the top of the Terminal by unlocking the top enclosure and pulling the hinged door forward.

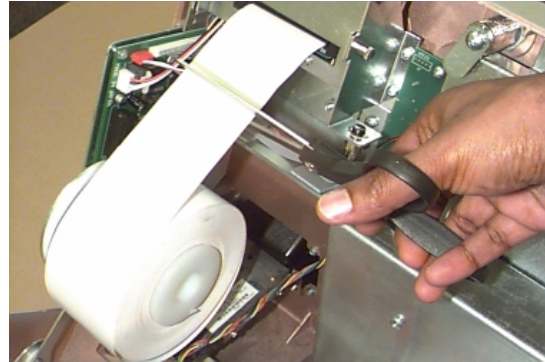
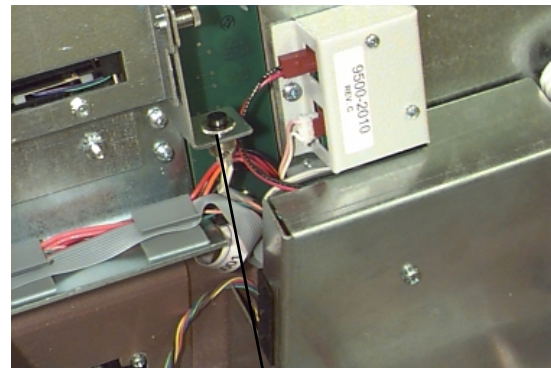

Figure 6-2. Cut any paper between the roll and the printer feed path with scissors.

2. Remove any paper that remains in the paper path as follows:
 - a. If paper remains on the roll, cut the paper between the roll and the printer with a pair of scissors as shown in Figure 6.2. Use the RECEIPT PRINTER PAPER FEED BUTTON to feed the paper through the paper path until all paper comes out the front of the printer.

NOTE:

Do not pull the paper backward through the printer. This may leave paper fragments that can cause paper jams.



FEED BUTTON

Figure 6-3. The PAPER FEED BUTTON.

SECTION 6 - MAINTENANCE

3. Push the paper spool (or partial roll of paper) from its location in Figure 6-4A to the position shown in Figure 6-4B.

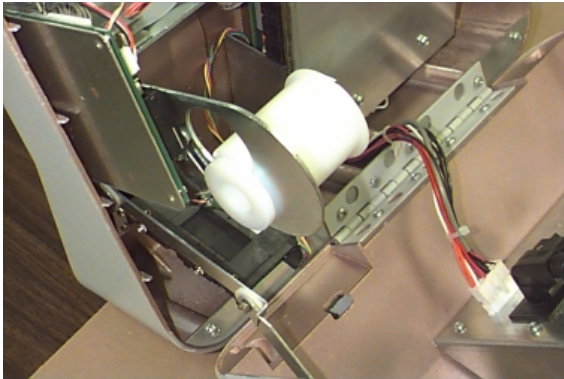

Figure 6-4A. Paper Spool in its normal operating position.

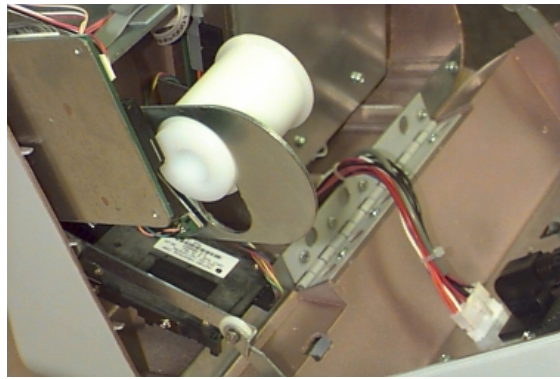

Figure 6-4B The Paper Spool in position for removal.

4. Remove the paper spool from the paper support bracket by pulling the slotted small end of the spool out of the bracket.
5. Remove the tab securing the end of the new paper roll to itself. Use scissors to cut off all of the paper up to and including the glue tab. Insert the paper spool into the new roll of paper (a 6-inch roll of 60-mm wide thermal paper). Be sure the paper spool is inserted so that the paper will feed **from the top of the roll** when it is installed on the paper bracket. Refer to Figures 6-5A and 6-5B.



Figure 6-5A. The paper and paper spool.



Figure 6-5B. Spool inserted into the roll of paper.

SECTION 6 - MAINTENANCE

- Place the paper roll and paper spool back on the paper bracket by sliding the small slotted end of the spool into the large hole in the bracket as shown in Figure 6-6A. Push the paper and spool into the operating position to lock them in place as seen in Figure 6-6B.

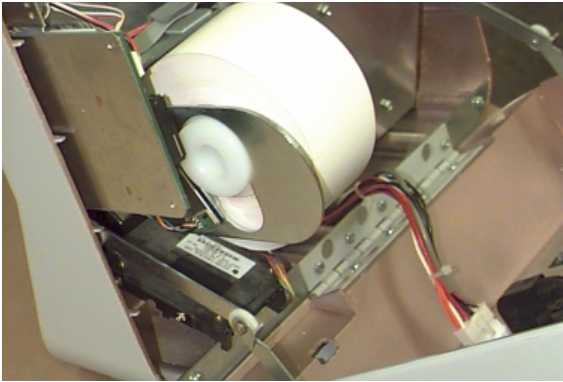

Figure 6-6A. Placing the paper roll and spool on the paper bracket.

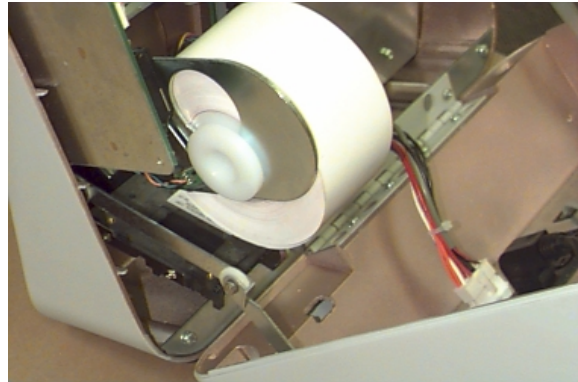

Figure 6-6B. Paper roll and spool in place for operation.

- Once the paper roll and spool are installed on the paper bracket, take the end of paper roll and feed it into the printer path paper entrance. Refer to Figure 6-7.
- Once the paper is fed into the paper path entrance, the printer will activate and automatically feed the paper through the printer and out the exit.
- Close and lock the Terminal.

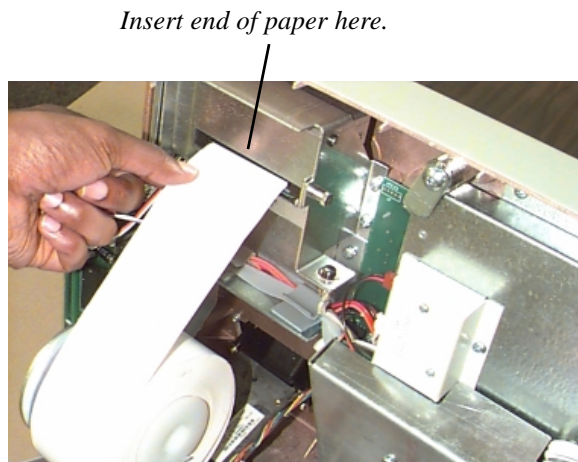

Figure 6-7. Feeding paper into the printer.

SECTION 6 - MAINTENANCE

THIS PAGE INTENTIONALLY LEFT BLANK.

SECTION 7
JOURNAL ENTRIES

SECTION 7 - JOURNAL ENTRIES

JOURNAL ENTRIES

Journal entries are printed on a per transaction basis. Each new entry begins with a blank line. The following is an example of a typical journal entry. In the case of a communications error, most of this information is omitted and an error code would be printed.

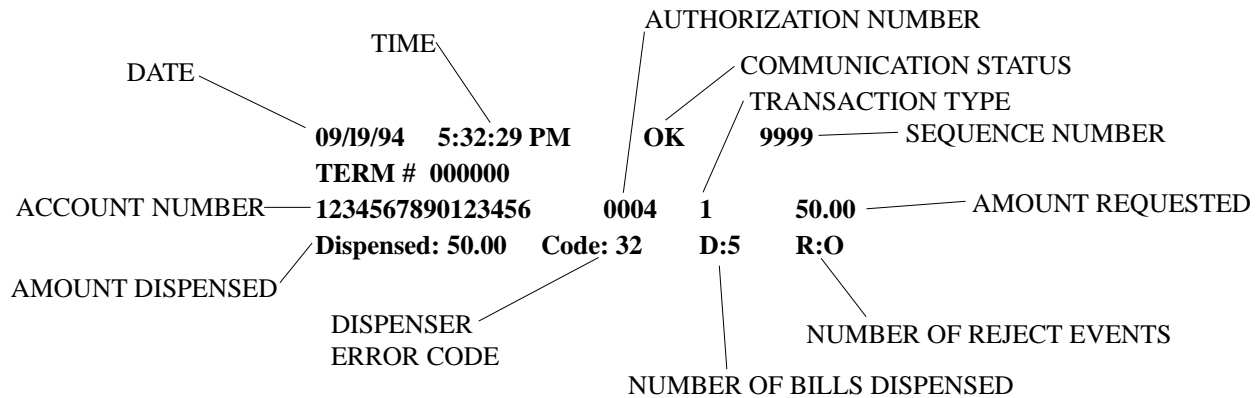

The transaction types are:

- 1 - Withdrawal from checking
- 2 - Withdrawal from savings
- 3 - Withdrawal from credit card
- 4 - Transfer checking to savings
- 5 - Transfer savings to checking
- 6 - Transfer credit to checking
- 7 - Transfer credit to savings
- 8 - Checking balance inquiry
- 9 - Savings balance inquiry
- 10 - Credit balance inquiry.

For an explanation of the Dispenser Error Codes consult Section 8, Error Recovery. Each reject event will result in one or more bills in the reject compartment inside the note cassette.

SECTION 8
ERROR RECOVERY

SECTION 8 - ERROR RECOVERY

INTRODUCTION

The Mako Dispenser operating system determines the operational status of each of its components by routinely performing a system status check. A status check is performed:

- 1.) During power up.
- 2.) Once every forty seconds while the dispenser is not in use.
- 3.) Before leaving the Management Functions main menu screen.
- 4.) After every transaction.

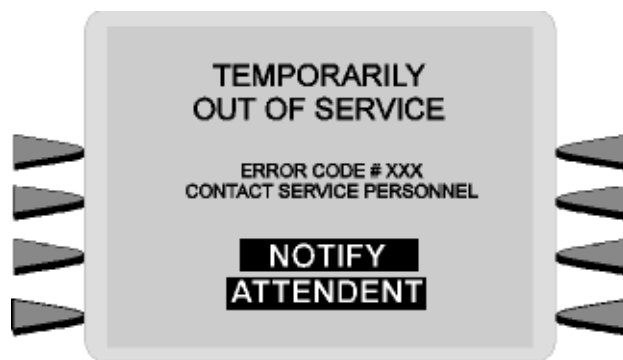

Figure 8-1. The “Out of Service” display.

An error detected during a status check will place the dispenser in an “OUT OF SERVICE” mode of operation and display the messages shown in Figure 8-1 on the LCD display screen.

ERROR RECOVERY

Many error conditions require the assistance of a qualified service technician to return the dispenser to normal operation. But there are some actions that the end user can perform to confirm the existence of a problem or correct simple problems.

Table 8-1, Error Recovery Procedures, provides a list of error conditions that can cause the dispenser to enter an “OUT OF SERVICE” condition. The table lists the error codes, a description of each error message and possible corrective actions non-service personnel can perform in an attempt to return the unit to normal operation.

Many of the procedures direct you to RESET the dispenser as the first step. This action may be all that is necessary to clear the error indication. In other cases further actions may be necessary. If necessary, you will be directed to contact your service organization.

SECTION 8 - ERROR RECOVERY

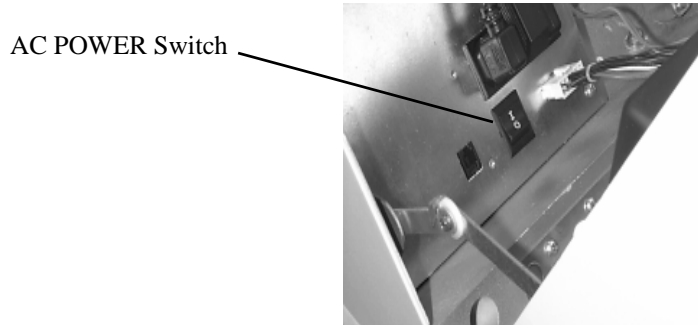

Figure 8-2. The location of the AC POWER Switch.

RESETTING THE CASH DISPENSER

In the “OUT OF SERVICE” mode of operation the dispenser will not respond to any inputs to the keypad or card reader.



Figure 8-3. The RESET ERROR/MANAGEMENT Menu.

Try to return the dispenser to normal operation by performing a RESET. To do this, turn the AC Power Switch (shown in Figure 8-2) OFF for a few seconds, then turn it back ON.

SECTION 8 - ERROR RECOVERY

After resetting the Dispenser, the RESET ERROR/MANAGEMENT Menu (refer to Figure 8-3.) is displayed on the LCD display screen. This menu allows you to perform two actions:

- 1.) Enter MANAGEMENT mode.
- 2.) RESET the error that caused the OUT OF SERVICE condition.

After selecting the RESET ERROR option, and if no additional error conditions exist, the CUSTOMER WELCOME screen should appear. At this point one further step is usually recommended to confirm that the dispenser is working normally, and that is to perform a TEST DISPENSE. The success of this operation is usually a good indication that the overall dispenser control system and dispensing mechanism are working normally.

It is possible that more than one error condition exists. In these cases, after resetting the original error message (or after performing a TEST DISPENSE) a different error message may be displayed. Address each error message according to the instructions given in Table 8-1, until all problems have been corrected and the Dispenser has been restored to normal operation, or you are instructed to contact your service organization.

MAKO DISPENSER ERROR CODES

Table 8-2, Mako Dispenser Error Codes, lists the status conditions that may be reported when performing diagnostic testing of the dispensing mechanism (via the DIAGNOSTICS Management Function). The status feedback is reported as a string of characters in the following form: EXXXXXXXXX, where 'E' indicates 'Error' and each of the nine 'X' characters in the string may take on the value of '0' or '1'. The nine characters correspond to the status descriptions 'S1' through 'S9' shown in the table. If a '1' is present in any 'X' character position, the status condition (S1-S9) corresponding to that position exists in the dispenser. Note that multiple error conditions may exist at the same time.

MISCELLANEOUS ERROR CODES

Table 8-3, Miscellaneous Error Codes, lists error codes not included in the previous tables. It is recommended that troubleshooting of these error conditions be coordinated through your service provider.

SECTION 8 - ERROR RECOVERY

TABLE 8-1 ERROR RECOVERY PROCEDURES		
Error/Status Code	Meaning	Recommended Actions
33	Dispenser detected no notes fed in three tries; cassette is probably empty.	<p>Turn off the Dispenser and open the security container. Inspect the dispensing mechanism feed path for jammed currency and currency sticking together. Clear the feed path as needed.</p> <p>Remove and inspect the cassette for damage that will prevent it from dispensing properly. Also, make sure the currency is fit for dispensing. If there is no currency in the cassette, see the IMPORTANT NOTE in the Recommended Actions for Error Code 182. If the suggested actions do not clear the feed failure indication, proceed with the remainder of this procedure.</p> <p>If there is no jammed currency, remove the first note from the cassette.</p> <p>Install the cassette in the dispenser mechanism and restore power to the Dispenser.</p> <p>When the RESET ERROR/MANAGEMENT menu is displayed on the LCD, press the RESET ERROR key.</p> <p>If the error appears again, close and lock the security container. Call your service provider.</p> <p>If the error clears, enter the MANAGEMENT FUNCTIONS when the Top Menu is displayed. Enter your password.</p> <p>When the MANAGEMENT FUNCTIONS menu is displayed select DIAGNOSTICS.</p> <p>Press the CLEAR DISPENSE ERROR key. The correct return code for a good purge is 'GQ'. If any other return code is displayed, contact your service provider.</p> <p>Press the TEST DISPENSE key. The correct return code for a good test dispense is 'GQ'. If any other return code is displayed contact your service provider.</p> <p>If the return codes are satisfactory, close and lock the security container.</p> <p>Place the Dispenser back in service.</p>

SECTION 8 - ERROR RECOVERY

TABLE 8-1 ERROR RECOVERY PROCEDURES		
Error/Status Code	Meaning	Recommended Actions
34	Mistracked note at feed.	See Recommended Actions for Error Code 33.
35	Mistracked note at double detect.	See Recommended Actions for Error Code 33.
36	Mistracked note at exit.	See Recommended Actions for Error Code 33.
37	Dispenser detected 5 or 6 note width errors in one dispense.	See Recommended Actions for Error Code 33.
38	Blocked exit.	See Recommended Actions for Error Code 33.
39	Too many notes.	<p>RESET the Dispenser.</p> <p>If the error appears again, close and lock the security container. Call your service provider.</p> <p>If the error clears, enter the MANAGEMENT FUNCTIONS when the Top Menu is displayed. Enter your password.</p> <p>When the MANAGEMENT FUNCTIONS menu is displayed select DIAGNOSTICS.</p> <p>Press the CLEAR DISPENSE ERROR key. The correct return code for a good purge is 'GQ' If any other return code is displayed, contact your service provider.</p> <p>Press the TEST DISPENSE key. The correct return code for a good test dispense is 'GQ'. If any other return code is displayed contact your service provider.</p> <p>If the return codes are satisfactory, close and lock the security container.</p> <p>Place the Dispenser back in service.</p>

SECTION 8 - ERROR RECOVERY

TABLE 8-1 ERROR RECOVERY PROCEDURES		
Error/Status Code	Meaning	Recommended Actions
42	Timing wheel error.	See Recommended Actions for Error Code 39.
44	Bad roller profile.	See Recommended Actions for Error Code 39.
45	Diverter error.	See Recommended Actions for Error Code 39.
46	Exit quantified.	See Recommended Actions for Error Code 39.
47	Note missing at double detect.	See Recommended Actions for Error Code 39.
48	Reject rate exceeded.	<p>The most probable cause of this error is poor quality currency.</p> <p>Open the security container.</p> <p>Remove the cassette and inspect the currency to make sure it's fit for dispensing (refer to guidance in Section 4, Handling Cassettes). Replace currency as needed.</p> <p>Follow the Recommended Actions for Error Code 39.</p>
49	Jam at exit.	See Recommended Actions for Error Code 39.
50	Interference recovery.	See Recommended Actions for Error Code 39.
51	Suspect exit accountancy.	See Recommended Actions for Error Code 39.
52	RAM error.	See Recommended Actions for Error Code 39.
53	EPROM error.	See Recommended Actions for Error Code 39.

SECTION 8 - ERROR RECOVERY

TABLE 8-1 ERROR RECOVERY PROCEDURES		
Error/Status Code	Meaning	Recommended Actions
54	Operation timeout.	See Recommended Actions for Error Code 39.
55	RAM corruption.	See Recommended Actions for Error Code 39.
56	Link Error	See Recommended Actions for Error Code 39.
128	Error in reply from the dispenser mechanism.	See Recommended Actions for Error Code 39.
129	No response from the dispenser mechanism.	See Recommended Actions for Error Code 39.
130	Command not acknowledged by the dispenser mechanism.	See Recommended Actions for Error Code 39.
131	Dispenser not ready to dispense.	See Recommended Actions for Error Code 39.
132	Dispenser detected 5 or 6 double-detect errors in one dispense.	See Recommended Actions for Error Code 39.
133	5 volts not present from dispenser mechanism.	See Recommended Actions for Error Code 39.
134	Dispenser Stacker exit is blocked.	See Recommended Actions for Error Code 39.
135	Dispenser jam; notes under document sensor for an excessive period of time.	See Recommended Actions for Error Code 39.
136	Modem initialization failed.	<p>RESET the Dispenser.</p> <p>If the error clears, put the Dispenser back in service.</p> <p>If the error appears again, close and lock the security container. Call your service provider.</p>

SECTION 8 - ERROR RECOVERY

TABLE 8-1 ERROR RECOVERY PROCEDURES		
Error/Status Code	Meaning	Recommended Actions
138	Print failure while printing to the receipt printer.	<p>Open the top enclosure of the Dispenser. Carefully clear the paper path with a business card or some similar object.</p> <p>With the aid of the paper feed switch feed cleanly cut paper through the printer and cutter mechanisms.</p> <p>Press the RESET switch.</p> <p>When the RESET ERROR/MANAGEMENT menu is displayed on the LCD, press the RESET ERROR key.</p> <p>If the error appears again, close and lock the security container. Call your service provider.</p>
139	Print controller not responding to commands.	See Recommended Actions for Error Code 136.
140	Timeout waiting for printer to be ready.	See Recommended Actions for Error Code 136.
141	Paper jam reported by controller during a status check.	See Recommended Actions for Error Code 138.
142	Dispenser did not understand the command sent from the main board.	See Recommended Actions for Error Code 136.
143	PTDF error.	See Recommended Actions for Error Code 136.
144	No reply from the security module or electronic journal.	See Recommended Actions for Error Code 136.
145	Error in reply from security module or electronic journal.	See Recommended Actions for Error Code 136.
146	No reply from command to electronic journal.	See Recommended Actions for Error Code 136.

SECTION 8 - ERROR RECOVERY

<p align="center">TABLE 8-1 ERROR RECOVERY PROCEDURES</p>		
Error/Status Code	Meaning	Recommended Actions
147	Error in reply from electronic journal.	See Recommended Actions for Error Code 136.
148	Write to electronic journal failed.	See Recommended Actions for Error Code 136.
149	Read from electronic journal failed.	See Recommended Actions for Error Code 136.
150	Status command to electronic journal failed.	See Recommended Actions for Error Code 136.
151	Electronic journal full.	<p>RESET the Dispenser.</p> <p>When the RESET ERROR/MANAGEMENT menu is displayed on the LCD, press the MANAGEMENT key.</p> <p>Enter your password. When the MANAGEMENT FUNCTIONS menu is displayed press the JOURNAL key.</p> <p>When the SELECT JOURNAL FUNCTIONS menu is displayed press the PRINT JOURNAL key.</p> <p>After the PRINT JOURNAL function is finished, press the EXIT key until the RESET ERROR/MANAGEMENT menu is displayed.</p> <p>Press the RESET ERROR key.</p> <p>If the error clears, put the Dispenser back in service.</p> <p>If the error appears again, close and lock the security container. Call your service provider.</p>

SECTION 8 - ERROR RECOVERY

TABLE 8-1 ERROR RECOVERY PROCEDURES		
Error/Status Code	Meaning	Recommended Actions
152	Electronic journal corrupt.	See Recommended Actions for Error Code 136.
153	Electronic journal mode.	See Recommended Actions for Error Code 136.
154	Unknown electronic journal status.	See Recommended Actions for Error Code 136.
155	Electronic journal modify record failure.	See Recommended Actions for Error Code 136.
157	Erase command to electronic journal failed.	See Recommended Actions for Error Code 136.
158	Format command to electronic journal failed.	See Recommended Actions for Error Code 136.
162	Electronic journal get serial number failed.	See Recommended Actions for Error Code 136.
163	Terminal did not answer.	See Recommended Actions for Error Code 136.
164	Terminal did not return call.	See Recommended Actions for Error Code 136.
165	Electronic journal not present.	See Recommended Actions for Error Code 136.
166	Bad dispense.	See Recommended Actions for Error Code 136.

SECTION 8 - ERROR RECOVERY

TABLE 8-1 ERROR RECOVERY PROCEDURES		
Error/Status Code	Meaning	Recommended Actions
182	Dispenser contains a low amount of currency; no more dispensing allowed.	<p>Open the security cabinet.</p> <p>Remove the cassette.</p> <p>Add currency to the cassette as needed.</p> <p>Place the cassette in the dispenser mechanism and close the security enclosure.</p> <p>Follow the Recommended Actions for Error Code 136.</p>
183	Receipt printer paper low.	<p>Add paper as needed. If this does not correct the problem, you may wish to temporarily disable detection of this condition by setting the LOW RECEIPT PAPER parameter to IN SERVICE (see Section 5) to allow operation until the problem can be corrected by your service provider.</p>

SECTION 8 - ERROR RECOVERY

TABLE 8-1 ERROR RECOVERY PROCEDURES		
Error/Status Code	Meaning	Recommended Actions
185	Phone number not configured.	Refer to Section 3, Operation and Setup, and Section 5, Management Functions, for procedures for checking and setting this parameter.
186	Bill size not configured correctly.	Refer to Section 3, Operation and Setup, and Section 5, Management Functions, for procedures for checking and setting this parameter.
187	Maximum withdrawal not configured.	Refer to Section 3, Operation and Setup, and Section 5, Management Functions, for procedures for checking and setting this parameter.
188	Communications key not configured.	Refer to Section 3, Operation and Setup, and Section 5, Management Functions, for procedures for checking and setting this parameter.
189	Terminal ID not configured.	Refer to Section 3, Operation and Setup, and Section 5, Management Functions, for procedures for checking and setting this parameter.
190	Master Key not configured.	Refer to Section 3, Operation and Setup, and Section 5, Management Functions, for procedures for checking and setting this parameter.
192	Communication error.	Call your service organization.
193	Electronic Journal (EJ) Baud Failed.	May have incorrect EJ module installed. The EJ should be yellow in color.
195	Receipt Paper Out.	The receipt paper is out , or a paper jam has occurred. Check the receipt printer.

SECTION 8 - ERROR RECOVERY

TABLE 8-1 ERROR RECOVERY PROCEDURES		
Error/Status Code	Meaning	Recommended Actions
196	Card Reader Failure.	Contact your service organization.
197	Dispenser detected a blocked Stacker during a dispense.	Contact your service organization.
198	Dispenser fed note into Stacker, but did not detect note going into Stacker.	Contact your service organization.
199	Cash Dispenser Width Errors.	Contact your service organization.
200	Dispenser fed extra note into the Stacker.	Contact your service organization.
201	Dispenser detected more than 6 errors (any dispenser errors) in one dispense.	Contact your service organization.
202	Dispenser is busy.	Contact your service organization.
203	SPED keypad is not replying to main board.	Contact your service organization.
204	Wrong Dispense.	Contact your service organization.
205	The SPED keypad reported a tamper condition.	Contact your service organization.
206	SPED Error. SPED could not perform a command successfully within multiple attempts.	Contact your service organization.
207	SPED not detected.	Contact your service organization.
208	Dispenser did not reply after a dispense command.	Contact your service organization.
211	The reply from the dispenser was invalid.	Contact your service organization.

SECTION 8 - ERROR RECOVERY

TABLE 8-2 MAKO DISPENSER ERROR CODES										
E		X	X	X	X	X	X	X	X	X
CODE	ERROR DESCRIPTION									
S1*	1 = STACKER BLOCKED.									
S2***	1 = LOW NOTE. NUMBER OF NOTES BELOW 30-50.									
S3*	1 = BIN EMPTY.									
S4*	1 = NOTE JAM.									
S5*	1 = NOTE FED BUT DID NOT ENTER STACKER.									
S6*	1 = EXTRA NOTE FED INTO STACKER.									
S7**	1 = FIVE OR SIX WIDTH ERRORS IN ONE DISPENSE.									
S8**	1 = FIVE OR SIX DOUBLE-DETECT ERRORS IN ONE DISPENSE.									
S9*	1 = SEVEN ERRORS IN ONE DISPENSE.									
*	THIS ERROR WILL STOP THE DISPENSER.									
**	THIS IS A WARNING ONLY; DOES NOT STOP THE DISPENSER.									
***	A LOW BIN CONDITION WILL NOT STOP A DISPENSE THAT IS IN PROGRESS, BUT NO NEW DISPENSES WILL BE PERMITTED UNTIL MORE NOTES ARE ADDED TO THE BIN.									

SECTION 8 - ERROR RECOVERY

**TABLE 8-3
MISCELLANEOUS ERROR CODES**

Error/Status Code	Meaning	Recommended Actions
1	Timeout	Contact your service provider for assistance.
3	BGD_NOANSWER	Contact your service provider for assistance.
4	Error in modem data	Contact your service provider for assistance.
6	BGD_NODIALTONE	Contact your service provider for assistance.
7	BGD_BUSY	Contact your service provider for assistance.
10	BGD_LOGON	Contact your service provider for assistance.
11	No connect	Contact your service provider for assistance.
13	BGD_DONE_GOOD	Contact your service provider for assistance.
14	EOT received	Contact your service provider for assistance.
15	Timed out waiting for EOT	Contact your service provider for assistance.
16	Communication problems	Contact your service provider for assistance.
65	Processor not communicating with modem correctly.	Contact your service provider for assistance.

SECTION 9
CUSTOMER TRANSACTIONS

SECTION 9 - CUSTOMER TRANSACTIONS

INTRODUCTION

The daily operation of the Mako Terminal is quite simple and straightforward. Once the terminal has been properly configured, in most cases the only management functions that will be used on a regular basis are the CLOSE functions. This section discusses the day-to-day operation of the terminal from a customer standpoint.

CUSTOMER TRANSACTIONS

A customer begins a transaction on the Mako Terminal by inserting a magnetic card in the card reader slot at the lower right corner of the front. The card must be inserted with the magnetic stripe facing DOWN and to the LEFT. The card is inserted until it stops, and then is pulled out. If the customer inserts the card incorrectly, a warning message will be displayed accompanied by several beeps to get their attention.

If your customers have problems READING their card, make sure they are inserting the card correctly. Most problems are the result of inserting the card incorrectly.

Once the card has been read in successfully, the customer must enter his secret Personal Identification Number, or PIN or code. Once the PIN has been entered, the transaction type and account are selected, and the desired amount of the transaction, if needed. The transaction will be processed just as it would for an actual ATM. The whole process only takes seconds.

Once the transaction is complete, a two-copy receipt will print out for the customer. If the transaction was successful, the receipt will indicate all of the details of the transaction. If the transaction was declined, a short receipt prints indicating the problem.

Figures 9-1 through 9-3 show the typical sequence of screens that would be displayed during Withdrawal, Transfer and Balance Inquiry transactions.

SECTION 9 - CUSTOMER TRANSACTIONS

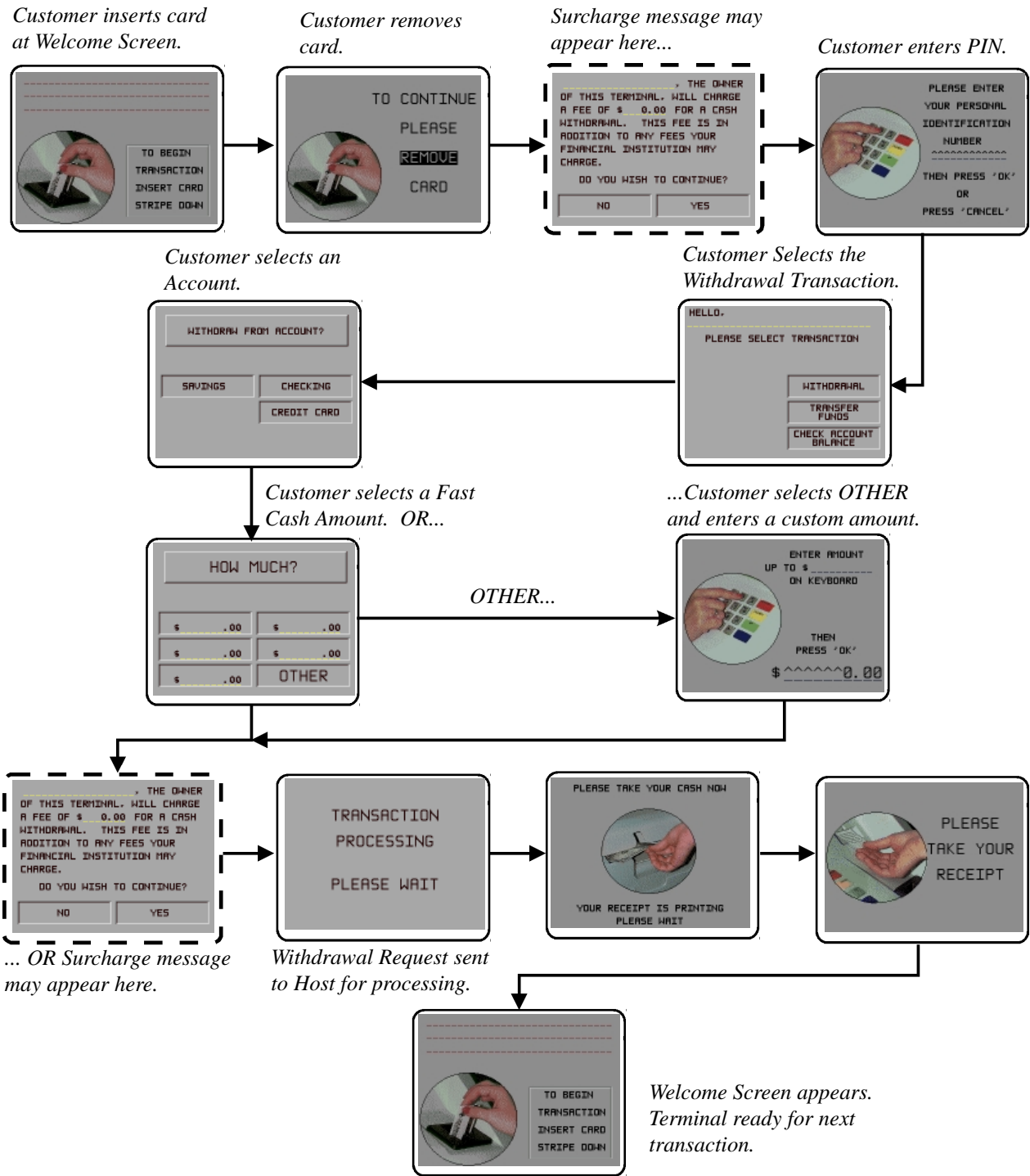

Figure 9-1. Withdrawal Transaction.

SECTION 9 - CUSTOMER TRANSACTIONS

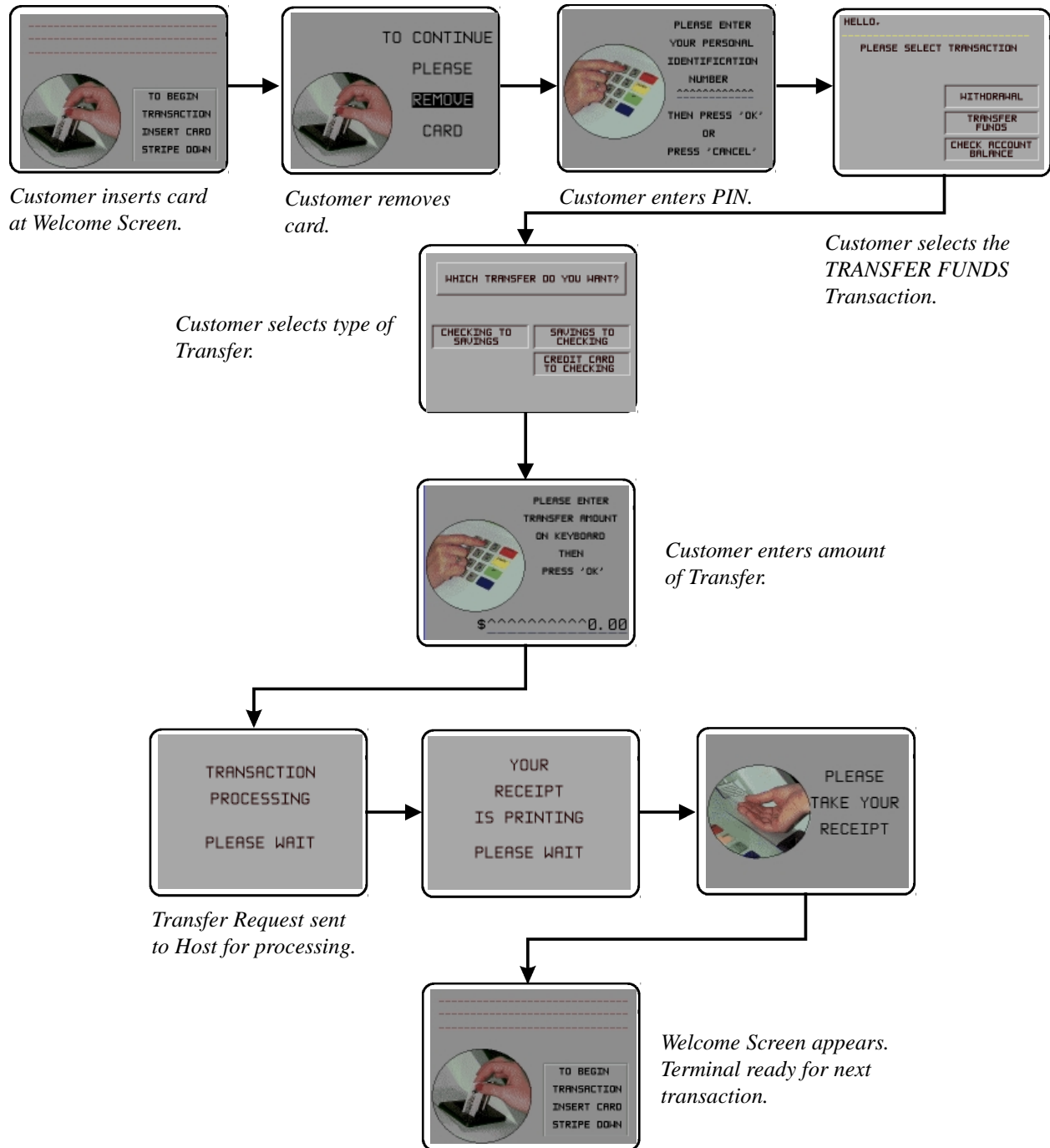

Figure 9-2. Transfer Transaction.

SECTION 9 - CUSTOMER TRANSACTIONS

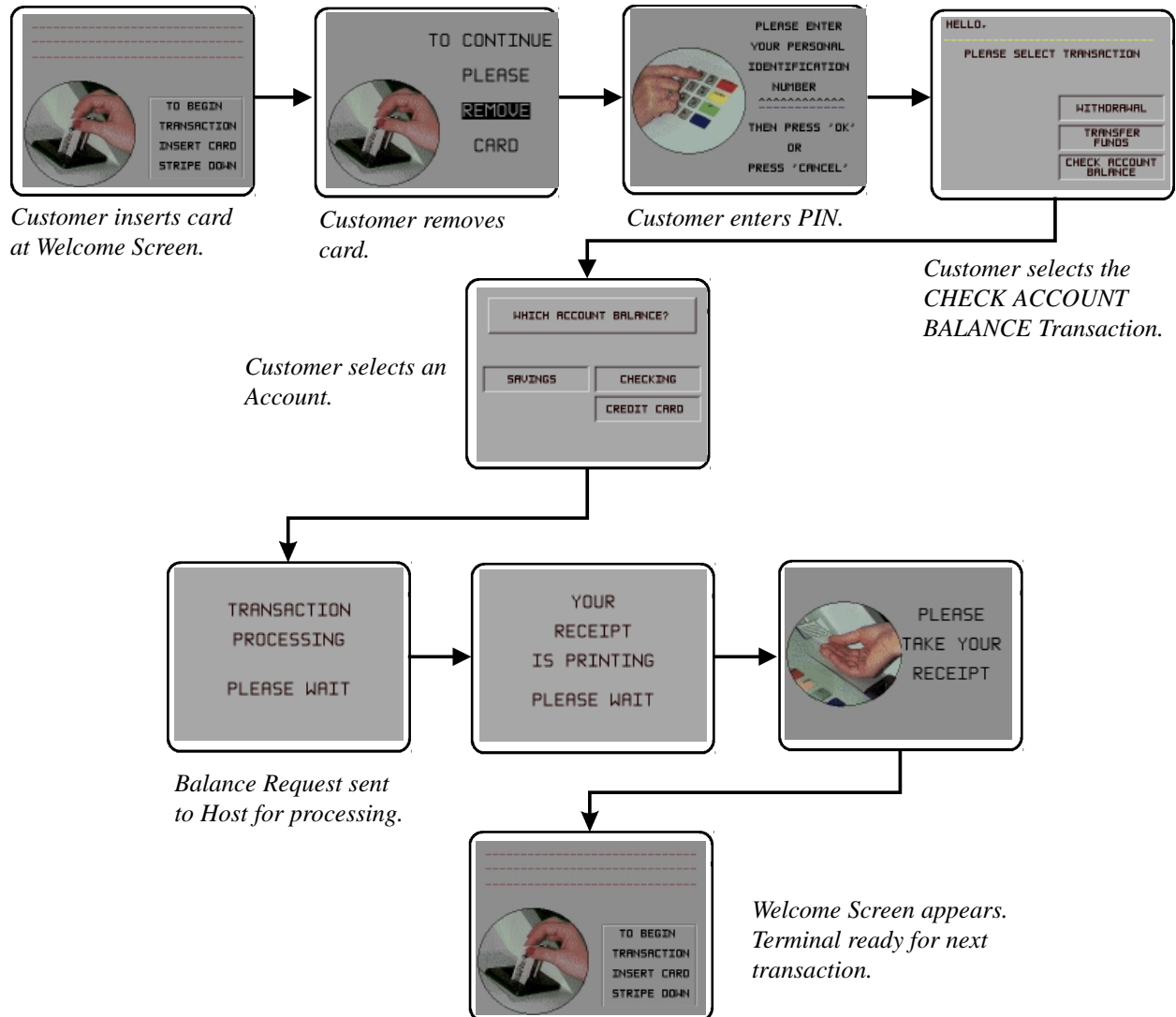

Figure 9-3. Balance Inquiry Transaction.

APPENDIX A
MECHANICAL COMBINATION LOCK
INSTRUCTIONS

APPENDIX A - MECHANICAL COMBINATION LOCK INSTRUCTIONS

ABOUT THE DIAL

There are two marks on the dial ring (see drawing). The index at the top is used for opening the lock, The index 30 degrees to the left is used only when changing the combination.

The dial should always be turned slowly and evenly. A revolution is counted each time the selected number is aligned with the opening index. **DO NOT TURN THE DIAL BACK TO COMPENSATE FOR OVER DIALING A NUMBER.** If, when dialing the combination, any number is turned beyond the index, the entire sequence must be repeated.

Locks are shipped on a factory setting of '50'. To unlock, turn the dial to the left (counterclockwise) **FOUR** turns stopping on '50'.

Then, turn the dial to the right until the bolt is retracted.

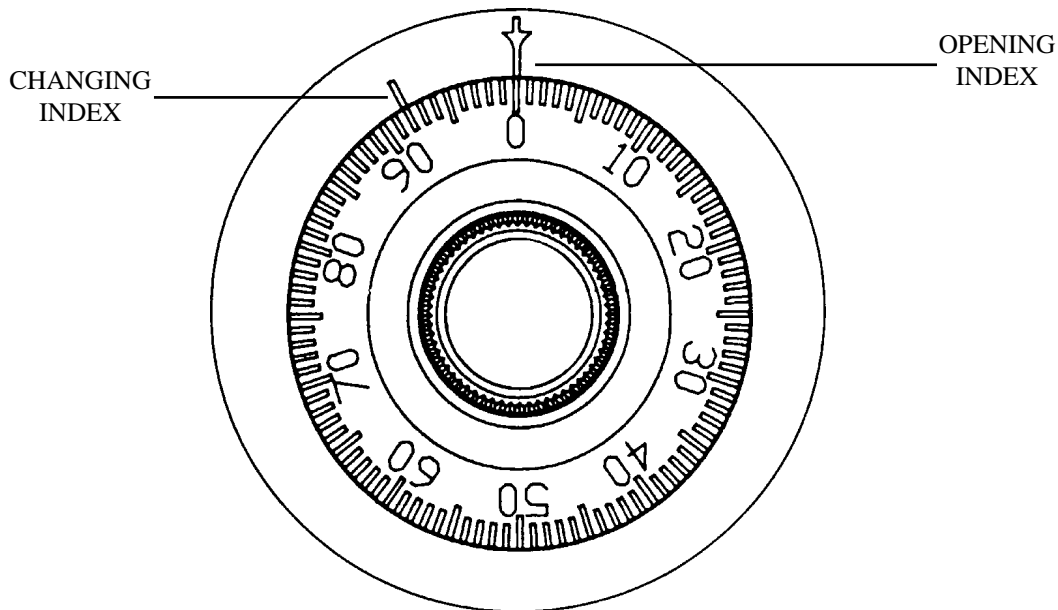

UNLOCKING 3-NUMBER COMBINATIONS (FOR EXAMPLE, "50-25-50")

1. Turn the dial to the **LEFT**, stopping when '50' is aligned with the opening index, the **FOURTH** time.
2. Turn the dial to the **RIGHT**, stopping when '25' is aligned with the opening index, the **THIRD** time.
3. Turn the dial to the **LEFT**, stopping when '50' is aligned with the opening index, the **SECOND** time.
4. Turn the dial slowly to the **RIGHT** until the bolt retracts.

To Lock

Turn the dial to the **LEFT** at least four full revolutions.

APPENDIX A - MECHANICAL COMBINATION LOCK INSTRUCTIONS

CHANGING THE COMBINATION

Select three new numbers. **DO NOT** use any number between 1 and 20 for the last number.

For maximum security, do not use numbers that end in 0 or 5, and do not use numbers in sequence: e.g., '27-48-86' is not as good as '27-86-48". Perform the following steps:

1. Dial the existing combination on the opening index (see steps 1-2-3 above, or the directions for opening when on the factory setting). Open door of container.
2. Dial the existing combination again, using the changing index.
3. With the last number set at the changing index, hold the dial securely and insert the change key in the keyhole in the back of the lock. Make sure the wing is entirely inside the lock and comes to a positive stop (see Figure 1) before turning the key.

*****WARNING*****

NEVER INSERT THE CHANGE KEY IN THE LOCK WHEN THE COVER IS REMOVED. BEFORE TURNING THE CHANGE KEY, MAKE SURE THE WING OF THE KEY IS FULLY INSERTED INTO THE LOCK.

4. Turn key one-quarter turn to the **LEFT** (see Figure 1). With the change key in this position, set the new combination as follows: turn the dial to the **LEFT**, stopping when the first number of the new combination aligns with the changing index the **FOURTH** time.

FIGURE 1

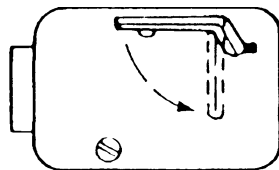
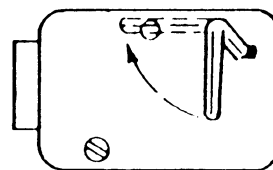

FIGURE 2



5. Turn dial to the **RIGHT**, stopping when the second number is aligned with the changing index, the **THIRD** time.
6. Turn the dial to the **LEFT**, stopping when the third number is aligned with the changing index, the **SECOND** time. Holding the dial in this position, turn the change key back to the **RIGHT** and remove it. (See Figure 2.) The new combination you have chosen is now set in the lock,

*****CAUTION*****

**BEFORE CLOSING THE UNIT
TRY THE NEW COMBINATION SEVERAL TIMES
USING THE OPENING INDEX.**

APPENDIX B
ELECTRONIC COMBINATION LOCK
INSTRUCTIONS

APPENDIX B - ELECTRONIC COMBINATION LOCK INSTRUCTIONS

ENTERING THE COMBINATION

The electronic lock combination consists of six digits. Upon arrival, the combination of the lock should already be set at 1-2-3-4-5-6. After installation on the safe has been completed, enter the preset combination and check for proper operation. After each keypress, the lock will beep. After the final digit has been entered, the lock will beep twice, and the open period will begin. When a valid combination has been entered, the operator will have approximately 3 seconds to open the lock. To open the lock, turn the dial clockwise. After the lock is opened, the door latch may be turned and the safe opened.

CHANGING THE COMBINATION

To change the combination of the lock, simply follow these directions.

- Enter six zeros.
- Enter the current combination. (Initially set at 1-2-3-4-5-6)
- Enter the new combination twice.
- The combination is now changed. Enter the new combination to open the lock.

LOCKOUT FEATURE

The electronic lock includes a WRONG TRY PENALTY lockout feature that prevents entry from unauthorized personnel. This feature performs as follows and CANNOT be disabled:

- Entry of four consecutive invalid combinations will disable the lock for 5 minutes. During this period, the panel LED will flash every 10 seconds. During this time the lock will remain closed and no other combination entries will be allowed.
- At the end of the lockout period, if two more consecutive invalid combinations are entered, the 5-minute lockout period will restart.

BATTERY REPLACEMENT

Repeated beeping while the lock is open indicates that the 9 volt battery, located in the battery box on the inside of the door, needs to be replaced. To remove the battery box cover, pull gently on the front of the box and slide the cover off. If the lock will not operate while the door is closed and locked, (i.e. no signal from the panel when a button is pressed), the battery is dead and the lock will need to be energized from the two round jumper terminals located on the front, right side of the push-button panel. To energize the lock, connect a 9-volt battery across the external terminals with the negative terminal of the battery facing up. While holding the battery against the terminals, enter the six-digit combination and open the lock and door. Replace the battery inside the battery box.

APPENDIX C
WARRANTY AND REPAIR
POLICIES/PROCEDURES

APPENDIX C - WARRANTY AND REPAIR POLICIES/PROCEDURES

Notices

Copyright ©1998 - Triton Systems, Inc.; 21405 B Street; Long Beach, MS 39560 USA

All Rights Reserved

This publication is protected by copyright and all rights are reserved. No part of it may be reproduced or transmitted by any means or in any form, without prior consent in writing from Triton Systems, Inc.

The information in this publication has been carefully checked and is believed to be accurate. However, Triton Systems, Inc. assumes no responsibility for any inaccuracies, errors, or omissions that may be contained in this document. In no event will Triton Systems, Inc. be liable for direct, indirect, special, incidental, or consequential damages resulting from any defect or omission in this manual, even if advised of the possibility of such damages.

In the interest of continued product development, Triton Systems, Inc. reserves the right to make improvements in its documentation and the products it describes at any time, without notice or obligation.

Trademark Acknowledgments

miniATM[™] is a trademark of Triton Systems, Inc.

APPENDIX C - WARRANTY AND REPAIR POLICIES/PROCEDURES

TRITON SYSTEMS, Inc.

Warranty Statement

Parts Only Limited Manufacturer's Warranty

Triton Systems, Inc. warrants the components of each Model 9600 Series Cash Dispenser, MAKO™ Cash Dispenser and SuperScrip™ Scrip Terminal, excluding software and related documentation, against any defect in materials and/or workmanship for a period of 13 months from the shipping date. The additional 30 days are intended to allow for the elapsed time between the shipment of the unit and its installation. If a component fails due to defects in materials and/or workmanship within the warranty period, Triton will furnish a new or refurbished component, at its discretion. Triton shall not be responsible for labor or other costs associated with installing the component; and the failed component shall be returned to Triton at the purchaser's expense. Triton shall not be responsible for misuse or abuse of a unit; and any attempts to remove or deface the serial number or date code on a unit or any component thereof, or any attempt to repair a unit or to repair or replace any component by anyone other than a service technician authorized by Triton shall void this warranty.

Limited Warranty covers normal use. Triton Systems does not warrant or cover damage:

- occurring during shipment of the equipment or components from or to Triton's facilities;
- caused by accident, impact with other objects, dropping, falls, spilled liquids, or immersion in liquids;
- caused by a disaster such as fire, flood, wind, earthquake, lightning, or other acts of God;
- caused by failure to provide a suitable installation environment for the equipment, including but not limited to, faulty wiring in the building in which the equipment is installed, installation in a facility with uncontrolled environmental conditions, failure to provide a dedicated electrical circuit on which the equipment operates, and/or lack of proper earth grounding for the equipment;
- caused by the use of the equipment for purposes other than those for which it was designed;
- resulting from improper maintenance;
- caused by any other abuse, misuse, mishandling, or misapplication.

Under no circumstances shall Triton Systems or its suppliers be liable for any special, incidental, or consequential damages based upon breach of warranty, breach of contract, negligence, strict liability, or any other legal theory. Such damages include, but are not limited to, loss of profits, loss of revenue, loss of data, loss of use of the equipment or any associated equipment, cost of capital, cost of substitute or replacement equipment, facilities or services, down time, purchaser's time, the claims of third parties, including customers, and injury to property.

Disclaimer of Warranties

The warranty stated above is the only warranty applicable to this product. All other warranties, expressed or implied (including all implied warranties of merchantability or fitness for a particular purpose or quality of service), are hereby disclaimed. No oral or written information, or advice given by Triton Systems, its agents or employees shall create a warranty or in any way increase the scope of this warranty.

APPENDIX C - WARRANTY AND REPAIR POLICIES/PROCEDURES

Other Claims

Shipping Damage

All equipment is shipped FOB, Triton's facilities. The organization or individual who has purchased the equipment assumes responsibility for the equipment once it leaves Triton's facilities.

Should your equipment be damaged in the process of shipment or delivery to your place of destination, we recommend the following course of action:

- If possible, call the shipping company before the driver leaves your delivery site. Make note of the damage on the "receipt of delivery" paperwork. If this is not possible, call them as soon as possible to report the damage.
- Take photographs of the damaged packaging prior to opening the boxes. If this is not possible, make note of key points, such as whether the equipment is on a pallet, if the banding is intact, how the boxes are damaged, etc. Keep all of the packaging for inspection by the shipping company.
- If you unpack the equipment, take photographs of the damaged equipment. If this is not possible, make note of the damages.
- You must file a claim with the shipper for shipping damages immediately after reporting the damages.

Should you specify the carrier, we recommend that you explore with this chosen carrier the policies and procedures regarding shipping damage claims prior to selecting them as your preferred carrier.

If the equipment receives structural damage and is in an un-installable condition, Triton will work with you to arrange for a replacement unit to be shipped as soon as possible. The purchaser will be billed for the replacement unit. Triton's Repair Technicians will repair the damaged unit after it is returned to our facilities. We will credit the purchaser's account for the full purchase price of the damaged unit, minus the cost of returning the unit to "like new" condition. Under no circumstances does Triton authorize anyone to complete structural damage repairs in the field. Therefore, we will not ship primary structural parts, such as a cabinet head or main cabinet body for repair in the field.

Authorized Installation and Service Providers

Triton Systems utilizes several nation-wide and regional authorized third party maintenance providers. All miniATM™ Cash Dispensers must be installed and serviced by service technicians certified by Triton. This includes authorized third party service technicians and technicians who have been factory trained by Triton to service *miniATM™* equipment. Installation or repairs attempted by unauthorized service technicians automatically voids the warranty on the product.

Please contact Triton Systems' Technical Services Department at (800) 259-6672 for a list of our third party service providers and/or to obtain information on the requirements and procedures for becoming a certified Triton service technician.

APPENDIX C - WARRANTY AND REPAIR POLICIES/PROCEDURES

Triton's Technical Services Department

The primary purpose of the Technical Services Department is to provide assistance to customers in the operation, trouble shooting, and repair of equipment manufactured by Triton. A toll-free phone number (1-800-259-6672) is provided for convenience. The Technical Services Department operates to serve our customers. The staff is trained to follow our policies and procedures to ensure fair and uniform treatment of all our customers.

Automated Voice Mail System. Our goal is to have a 'live' person answer 100% of all incoming calls (during regular support hours). On occasion, however, call loads may exceed the capacity of the staff. When this occurs, an automated voice mail system will answer the call, indicate to the caller that all Technical Support Specialists are busy assisting others, and ask the caller to leave detailed information about the nature of the call.

Should it become necessary to leave a voice mail message, the caller should state:

- their name
- the organization for which they work
- the serial number of the equipment they are calling about
- detailed description of the problem that they are experiencing
- phone number where they can be reached, including area code.

As Technical Support Specialists become available, they check for voice mail messages and return calls in the order in which they were received. By providing the information requested in the voice mail, the technician can be prepared when your call is returned. Triton asks you to be patient if you must leave voice mail, and assures you that your call is important to us and that we will respond promptly.

Calls for Service or Repair. Calls for service or repair will be accepted from authorized service technicians only. End users must contact either the sales organization that placed the equipment or an authorized third party service organization to obtain service. The sections that follow describe the policies and procedures that relate to the repair and replacement of malfunctioning equipment.

Questions on Operation of Equipment. Technical support is available to owners of Triton equipment and to qualified service personnel. When calling for help with the configuration or operation of a Triton product, the caller must provide either positive identification as a service technician or the serial number of a Triton terminal. Technical support is provided during normal business hours for the life of the product.

When calling for help with an operational Problem, please have available information pertaining to the nature of the trouble. This includes the type of equipment, examples of what is or is not happening, and the name of the processor that supports your terminal.

All questions pertaining to the settlement of accounts, transaction inquiries, and fund status must be directed to the processor. Triton does not have access to the information needed to answer questions relating to specific transactions.

APPENDIX C - WARRANTY AND REPAIR POLICIES/PROCEDURES

CONTACT INFORMATION

TRITON SYSTEMS, INC.
21405 B STREET
LONG BEACH, MS 39560

Sales:

(800) 367-7191
(228) 868-1317
(228) 868-0437 FAX

Service:

(800) 259-6672
(228) 868-0859 FAX

INDEX

INDEX

A

ACCOUNT NUMBER 7-2
 ACCOUNT TYPE 2-4
 ACCOUNT TYPES 5-129
 ACCOUNT TYPES 2-4
 ACTIVATE 5-120
 AD SCREENS 5-112
 AD SCREENS 2-7
 ADJUST VOLUME/CONTR 5-97
 ADMINISTRATION PASSWORD 5-36
 ADMINISTRATION PASSWORD 5-3
 ADMINISTRATION PASSWORD 5-2
 ALARM THRESHOLDS 5-115
 ALARM THRESHOLDS 2-4
 AMERICANS WITH DISABILITIES ACT 3-3
 AMOUNT DISPENSED 7-2
 AMOUNT REQUESTED 7-2
 ATM MONITORING 5-107
 AUTHORIZATION NUMBER 7-2

B

BACKUP NUMBER 5-86
 BACKUP NUMBER, TRITON CONNECT 5-101, 5-104
 BALANCE INQUIRY 4-2
 BASIC OPERATION 3-2
 BAUD RATE 5-93
 BILLS DISPENSED 7-2
 BLOCK ISO'S 5-64
 BLUE KEY 3-3
 BRAILLE 3-3

C

CARD READER 5-63
 CARD READER 8-3
 CASSETTE CLOSE 1-4, 5-14
 CASSETTE SETUP 5-67
 CHANGE MESSAGES 5-48
 CHANGE SCHEDULE 5-8
 CHECK DIGIT 5-75, 5-77, 5-80, 5-82
 CHECKING BALANCE INQUIRY 7-2
 CLEANING 6-2
 CLEAR JOURNAL 5-32
 CLOSE 2-5, 5-3, 5-6, 5-9, 5-10, 5-11, 5-14
 CLOSE SCHEDULING 2-3
 COLOR DISPLAY 2-9

COMMS. KEY 5-83
 COMMUNICATION HEADER 5-113
 COMMUNICATION STATUS 7-2
 COMPUSERVE ID 5-89
 CONFIGURATION 3-6
 CONFIGURATION PARAMETERS 3-6
 COUPON AWARDS 5-45
 COUPON OPTIONS 3-9
 CREDIT BALANCE INQUIRY. 7-2
 CURRENCY CASSETTE 5-70
 CUSTOMER OPTION 5-29
 CUSTOMER TRANSACTION 3-2, 3-5, 5-2
 CUSTOMER TRANSACTION 2-9, 3-2, 3-3, 3-5
 CUSTOMER TRANSACTIONS 3-2, 3-5
 CUSTOMER TRANSACTIONS 4-2
 CUSTOMER TRANSACTIONS 3-2, 3-3, 3-5
 CUSTOMER WELCOME 3-2

D

DATAPAK ACCESS CODE 5-87
 DATE 5-126, 7-2
 DATE/TIME FORMAT 2-10
 DAY CLOSE 1-4, 2-5, 5-10, 5-11
 DEACTIVATE 5-121
 DIAGNOSTICS 5-3, 5-15, 5-75, 5-77, 5-80, 5-82
 DIAL MODE 5-91
 DIAL MODE 5-91
 DIAL RATE 5-92
 DIAL RATE 5-92
 DISABLE CALL BACK 5-105
 DISABLE COUPON AWARDS 5-45
 DISABLE CUST. OPTION 5-29
 DISABLE SURCHARGE 5-62
 DISABLE TRITON CONNECT 5-106
 DOWNLOAD WORKING KEYS 5-83

E

ELECTRONIC JOURNAL 2-4
 ELECTRONIC JOURNAL 2-4
 ENABLE CALL BACK 5-105
 ENABLE COUPON AWARDS 5-45
 ENABLE CUST. OPTION 5-29
 ENABLE SURCHARGE 5-62
 ENABLE TRITON CONNECT 5-106
 ENABLE/DISABLE CALL BACK 5-105
 ENABLE/DISABLE SURCHARGE 5-62
 ENABLE/DISABLE TRITON CONNECT 5-106

INDEX

ENGLISH/INGLES 5-27
 ENTER COMMS. KEY 5-83
 ENTER LEVEL PRIZE MSG. 5-43
 ENTER MASTER KEY 5-76
 ENTER MKEY INDEX 5-74, 5-79, 5-81
 ENTER QTY. IN CASSETTE 5-13
 ENTER RANDOM PRIZE MSG. 5-44
 EPROM ACCESS 2-5
 EPROM ACCESS CODE 2-5
 EPROM ACCESS CODE 2-5
 ERROR CODE 7-2
 ERROR MESSAGE 3-7
 ERROR RECOVERY 8-2
 EXIT MESSAGE 2-4
 EXIT MESSAGE, CHANGE 5-54
 EXTENDED AMOUNT 5-71
 EXTENDED AMOUNTS 2-9
 EXTENDED FIELD-LENGTHS 2-6

F

FAST CASH AMOUNT 5-72
 FEATURE NUMBER 5-122
 FEATURES 2-2
 "FIT" DOCUMENTS 4-2
 FORMAT EXPANSION MEMORY CARD 5-19
 FORMAT MEMORY EXP. CARD 5-19
 FORMATTING A MEMORY EXPANSION MODULE
 AT THE LOCAL 2-7
 FORMATTING A MEMORY EXPANSION MODULE
 FROM THE TRIT 2-7
 FORMATTING A MEMORY MODULE 2-6
 FUNCTION AVAILABILITY 5-3

G

GENERAL FEATURES 2-2
 GRAPHICS MEMORY 2-6

H

HEARTBEAT MESSAGE 5-109
 HOST TOTALS 5-10, 5-11

I

INITIAL CONFIGURATION 3-6
 INJECT MASTER KEY 5-78
 INQUIRY 5-31

INTERNATIONAL CURRENCY 5-68
 INTERNATIONAL MONETARY SUPPORT 2-6
 ISO 5-64

J

JOURNAL 5-30
 JOURNAL ENTRIES 7-2
 JOURNAL ENTRIES 7-2
 JOURNAL THRESHOLD 5-117
 JOURNAL TRANSFER 2-4

K

KEY MANAGEMENT 5-73
 KEYPAD 3-3
 KEYPAD 2-8, 3-5, 8-3
 KEYPAD OPERATION 3-3

L

LANGUAGE OPTION 2-5, 3-9
 LANGUAGE OPTIONS 5-26
 LANGUAGE/IDIOMA 5-26
 LCD DISPLAY 3-3
 LEVEL PRIZE AMOUNT 5-46
 LEVEL PRIZE MSG 5-43
 LOW CASH THRESHOLD 5-116
 LOW RECEIPT PAPER 5-40

M

MAC MASTER KEY 3-8, 5-74
 MAC WORKING KEY 3-8, 5-79
 MAINTENANCE 6-2
 MANAGEMENT FUNCTIONS 3-2, 3-5, 5-2, 5-3, 5-5, 5-30, 5-34
 MANAGEMENT FUNCTIONS 3-5, 5-2, 5-27, 5-28
 MANAGEMENT FUNCTIONS 3-2, 5-36, 5-70
 MANAGEMENT FUNCTIONS CHART 5-3
 MANAGEMENT FUNCTIONS CHART 5-4
 MANAGEMENT FUNCTIONS MENU 5-2
 MARKETING MESSAGE 5-49
 MARKETING MESSAGE 3-8
 MASTER KEY 5-75, 5-77, 5-80, 5-81
 MASTER KEY 5-75, 5-76, 5-79
 MASTER KEY 3-8
 MASTER KEY 5-74, 5-75, 5-76, 5-77, 5-79, 5-80, 5-81
 MASTER PASSWORD 5-2, 5-34, 5-35, 5-36, 5-38, 5-39, 5-40, 5-41

INDEX

MASTER PASSWORD 5-35, 5-36
 MASTER PASSWORD 3-5, 3-6, 5-35
 MAXIMUM AMOUNT 5-69
 MAXIMUM AMOUNT 3-7
 MAXIMUM AMOUNT 3-7
 MEDIA CONDITION 4-2
 MEMORY EXPANSION MODULES 2-6
 MENU BASED OPERATION 3-2
 MENU-BASED OPERATION 3-2
 MODEM SETUP 5-90
 MODEM SETUP STRING 5-94
 MODEM SPEAKER ON/OFF 5-24
 MONETARY SUPPORT 2-6
 MORE (TERMINAL PARAMETERS) 5-114
 MORE DIAGNOSTICS 5-22
 MORE TERMINAL PARAMETERS 5-96
 MULTIPLE AMOUNT 5-70

N

NEW FEATURES 2-2
 NEW OR UNCIRCULATED CURRENCY 4-2

O

OUT OF SERVICEMODE 8-2

P

PAPER 2-5, 4-2, 5-33, 5-39
 PAPER LOW 2-6
 PAPER LOW OPTION 2-6
 PASSWORD 3-5, 3-6
 PASSWORD MAINTENANCE 5-34
 PIN 5-63
 PIN 4-2
 PIN MASTER KEY 3-8, 5-76
 PIN WORKING KEY 3-8, 5-81
 PREDIAL 5-87, 5-88
 PREDIAL 2-4
 PREDIAL CAPABILITY 2-4
 PRIMARY NUMBER 5-85
 PRIMARY NUMBER 5-86
 PRIMARY NUMBER, TERMINAL 5-85
 PRIMARY NUMBER, TRITON CONNECT 5-100, 5-103
 PRIMING THE CASSETTE 4-3
 PRINT JOURNAL 2-5, 5-31
 PRINT JOURNAL 2-5
 PRINT LAST X ENTRIES 5-33

PRINT LENGTH 5-39
 PRINTER GRAPHICS 5-41
 PRINTER GRAPHICS 2-8
 PRINTER SETTINGS 5-38
 PRIZE COUPONS 2-8
 PRIZE COUPONS 2-8
 PROCESSOR 1-3

R

RANDOM PRIZE MSG 5-44
 RANDOM WINNING % 5-47
 RANDOM/LEVEL PRIZE COUPONS 5-42
 RECEIPT OPTION 5-98
 RECEIPT OPTION 2-8, 3-9
 RECEIPT OPTIONS 5-98
 RECEIPT PAPER LOW, ON/OFF 5-40
 RECEIPT PRINTER 5-75, 5-77, 5-80, 5-82
 RECEIPT PRINTER 2-6
 RECEIPT PRINTER 2-5, 3-9, 5-11, 5-31
 RECEIPT PRINTER GRAPHICS 2-8
 REJECT EVENTS 7-2
 REMOVING A CASSETTE 4-2, 4-3
 REPLENISHING CASSETTES 4-2
 REPLENISHING RECEIPT PAPER 6-3
 RESET 8-3
 RESET SEQ # 5-59
 RESET SWITCH 3-5
 RESET/TEST MODEM 5-23, 5-91, 5-95
 RESETTING THE CASH DISPENSER 8-3

S

SAVINGS BALANCE INQUIRY 7-2
 SCAN CARD 5-25
 SCHEDULE CLOSE 5-7
 SCHEDULED JOURNAL 5-118
 SCREEN KEYS 3-5
 SCREEN TIMEOUT 3-2
 SELECT FEATURE NUMBER 5-122
 SEND TERMINAL TOTALS 5-12
 SEQUENCE NUMBER 7-2
 SET CLOCK 5-123, 5-124, 5-125
 SET DATE 5-126
 SET TERMINAL # 5-58
 SET TERMINAL PARAMETERS 5-57
 SET TIME 5-8, 5-127
 SETUP PARAMETERS 3-9
 SETUP PARAMETERS 3-9

INDEX

SPANISH/ESPAÑOL 5-28
 STATUS 5-16
 STATUS CHECK 8-2
 STATUS MONITORING 5-108
 STATUS MONITORING 2-5
 STORE MESSAGE 5-48, 5-55
 STORE MESSAGE 3-8
 STORE MESSAGE 2-8
 SURCHARGE AMOUNT 5-66
 SURCHARGE LOCATION 5-63
 SURCHARGE MESSAGES 5-50
 SURCHARGE MODE 3-6, 3-7, 5-60
 SURCHARGE MODE 3-6
 SURCHARGE OWNER 5-48, 5-53
 SURCHARGE OWNER 3-8
 SURCHARGE OWNER 3-8
 SURCHARGE PERCENT 5-61

T

TELEPHONE 5-84, 5-87, 5-88
 TELEPHONE BACKUP NUMBER 5-86
 TELEPHONE NUMBER 3-6
 TELEPHONE PRIMARY NUMBER 5-85
 TERMINAL # 5-58
 TERMINAL CONFIGURATION 5-37, 5-48, 5-57
 TERMINAL CONFIGURATION 2-9
 TERMINAL NUMBER 5-83
 TERMINAL NUMBER 3-6
 TERMINAL NUMBER 5-58
 TERMINAL OWNER 5-48, 5-56
 TERMINAL OWNER 3-8
 TERMINAL OWNER 3-8
 TERMINAL PARAMETERS 5-57, 5-60
 TERMINAL PARAMETERS 3-5
 TEST DISPENSE 5-18, 8-4
 TEST RECEIPT PRINTER 5-20
 TEXT, ENTERING VIA KEYPAD 3-3
 TEXT-BASED AD SCREENS 2-7
 TEXT-BASED AD SCREENS 2-7
 TIME 5-127, 7-2
 TIME-OUT 3-2
 TOP MENU 3-2, 3-5
 TOP MENU 3-2, 5-2
 TRANSACTION TYPE 7-2
 TRANSACTION TYPE 2-4
 TRANSACTION TYPES 5-128
 TRANSACTION TYPES 2-4

TRANSACTION TYPES 7-2
 TRANSACTIONS 4-2
 TRANSFER 7-2
 TRANSFER TRANSACTION 4-2
 TRIAL CASSETTE BALANCE 5-7, 5-9, 5-12, 5-115, 5-116, 5-117, 5-118, 5-128
 TRIAL CLOSE 5-10, 5-11
 TRITON CONNECT 5-99, 5-102
 TRITON CONNECT 2-5, 2-9
 TRITON CONNECT BACKUP NUMBER 5-101, 5-104
 TRITON CONNECT PRIMARY NUMBER 5-100, 5-103
 TRITON CONNECT™ 2-9

U

USED CURRENCY 4-2

V

VERSION # 5-21
 VERSION #'S 5-21
 VIEW/MODIFY OPTIONS 5-119

W

WELCOME MESSAGE 5-52
 WELCOME MESSAGE 3-9
 WITHDRAWAL 7-2
 WITHDRAWAL 3-6, 3-7, 5-63
 WITHDRAWAL AMOUNTS 5-67
 WITHDRAWAL TRANSACTION 4-2
 WITHDRAWAL TRANSACTION 3-6, 3-7, 5-62, 5-69, 5-70, 5-72